



maxema®

**PLAY  
THE  
COLOR**

MAXEMA.COM













**YOU  
WANT**



MADE IN ITALY  
— PRODOTTO  
IN ITALIA —  
FABRIQUE EN  
ITALIE — FABRI-  
CADO EN ITALIA

# Indice

## contents

<b>Introduzione</b>	<b>06</b>				
Introduction					
<hr/>					
<b>Mood</b>	<b>10</b>				
meccanismo a scatto / retractable					
MD1 – C M1 	14				
MD1 – GOM CB M1 	16				
MD1 – GOM C M1 	18				
MD1 – GOM 30 M1 	20				
MD1 – C M2 	22				
MD1 – C M3 	23				
<hr/>					
<b>Flow Pure</b>	<b>24</b>				
meccanismo a rotazione / twist-action					
F2 P – MATT B	28				
F2 P – MATT CB	30				
F2 P – MATT	32				
F2 P – MATT F	34				
F2 P – C	36				
F2 P – B 30	38				
F2 P – GOM K	40				
F2 P – GOM CB	42				
F2 P – GOM 30	44				
F2 P – GOM CF	46				
F2 P – GOM KF	47				
F2 P – GOM 30 F	48				
<hr/>					
<b>Flow</b>	<b>50</b>				
meccanismo a rotazione / twist-action					
F1 – MATT AL 	54				
F1 – B 30 CR	56				
F1 – C CR	58				
F1 – 30 CR	60				
F1 T – GOM C CR	62				
F1 T – GOM CB CR	64				
F1 T – GOM 30 CR	66				
<hr/>					
<b>Dot</b>	<b>68</b>				
meccanismo a scatto / retractable					
D1 – MATT B 	72				
D1 – MATT CB 	74				
D1 – MATT 	76				
D1 – MATT K 	78				
D1 – MATT F 	80				
D1 – B CR	82				
D1 – BC CR	84				
D1 – B 30 CR	86				
D1 – CB CR	88				
D1 – C CR	90				
D1 – 30 CR	92				
D1 – GOM K	94				
<hr/>					
D1 – GOM CB CR	96				
D1 – GOM C CR	98				
D1 – GOM 30 CR	100				
D1 – C GOLD	102				
D1 – GOM CB F CR	103				
D1 – GOM KF CR	104				
D1 – GOM 30 F CR	105				
<hr/>					
<b>Zink</b>	<b>106</b>				
meccanismo a rotazione / twist-action					
Z1 – CB 	110				
Z1 – C	112				
Z1 – 30	114				
Z1 – CF	116				
<hr/>					
<b>View</b>	<b>118</b>				
meccanismo a rotazione / twist-action					
V1 – C CR / V1 – C CR T	122				
V1 – 30 CR / V1 – 30 CR T	124				
V1 – AL CR / V1 – AL CR T	125				
V1 – GOM C CR /	126				
V1 – GOM C CR T					
<hr/>					
<b>Tag</b>	<b>128</b>				
meccanismo a rotazione / twist-action					
TA1 – MATT AL B	132				
TA1 – B CR	134				
TA1 – CB CR	135				
TA1 – MATT AL	136				
TA1 – FROST AL	137				
TA1 – C CR	138				
TA1 – 30 CR	140				
TA1 – GOM C CR	141				
TA1 – MET AL	142				
TA1 – AL CR	143				
<hr/>					
<b>Icon</b>	<b>144</b>				
meccanismo a rotazione / twist-action					
IC400 – C	148				
IC400 – MATT	149				
IC400 – 30	150				
IC400 – FROST	151				
IC400 – MATT AL	152				
IC400 – C CR	154				
IC400 – FROST AL	156				
IC400 – 30 CR	157				
IC400 – C GOLD	158				
IC400 – MET AL	159				
IC400 – AL CR	159				
<hr/>					
<b>Tag green</b>	<b>160</b>				
meccanismo a rotazione / twist-action					
TA2 – B	166				
TA2 – BC	167				
<hr/>					
<b>Icon green</b>	<b>168</b>				
meccanismo a rotazione / twist-action					
IG2 – BC	174				
IG2 – C	175				
<hr/>					
<b>Ethic</b>	<b>176</b>				
meccanismo a rotazione / twist-action					
ET900 – MULTICOLOUR	180				
ET900 – FLAG	181				
ET900 – C FLAG	181				
ET900 – B	182				
ET900 – BC	183				
ET900 – C CR	184				
ET900 – C GOLD	185				
ET900 – AL	186				
ET900 – AL CR	187				
ET900 – AL FLAG	187				
ET900 – MET CR	188				
ET900 – MET AL	189				
<hr/>					
<b>Next</b>	<b>190</b>				
meccanismo a scatto / retractable					
NX400 – C CR	194				
NX400 – 30 CR	195				
NX400 – FROST AL	196				
NX400 – MET AL	197				
NX400 – AL CR	197				
NX400 – GOM C CR	198				
NX400 – GOM AL	199				
<hr/>					
<b>Pixel</b>	<b>200</b>				
meccanismo a scatto / retractable					
PX40 – MATT CB	204				
PX40 – MATT CR	206				
PX40 – B	208				
PX40 – C	209				
PX40 – 30	210				
PX40 – FROST NEUTRAL	211				
PX40 – FROST <b>NEW COLORS</b>	212				
PX40 – GOM C CR	214				
PX40 – GOM 30 CR	215				
<hr/>					
<b>Bay</b>	<b>216</b>				
meccanismo a rotazione / twist-action					
B500 – MATT BC	220				
B500 – MATT	222				
B500 – BC	224				
B500 – C	225				
B500 – 30	226				
B500 – FROST	227				
<hr/>					
<b>Packaging</b>	<b>228</b>				
supporti di vendita	230				
sales support					
palette colori	240				
colour palette					
codici pantone	241				
pantone codes					
inchiostri e refill	242				
inks and refills					



# Maxema

solo una penna?  
*Maxema, just a pen?*

## Progettazione

### *Planning*

**IT** Non tutti sanno che per costruire una penna curata in ogni dettaglio può essere necessario anche più di un anno di lavoro. Costruire lo stampo per ogni componente di una penna è un'operazione molto complessa: anche l'errore di un centesimo di millimetro può comprometterne la funzionalità. Ecco perché la progettazione e la produzione delle nostre penne avviene interamente nella nostra unica sede italiana, dove possiamo controllare ogni passaggio: dai primi prototipi fino alla commercializzazione del prodotto definitivo.

**EN** Not everyone knows that it can take more than a year to create a new pen in which every detail is handled with meticulous care. Creating the moulds for each component of the pen is a highly complex operation: a mistake of even a hundredth of a millimetre could jeopardise its operation. This is why all our pens are designed and manufactured entirely in our only Italian premises, where we are able to monitor every stage: from the first prototypes right down to marketing the finished product.

## Design

### *Design*

**IT** Il design delle nostre penne è frutto di costanti ricerche stilistiche: le linee e i colori si ispirano alle tendenze del momento. Una penna promozionale deve attrarre ed emozionare, oltre che essere un supporto di qualità per il messaggio che le viene affidato. Estetica, originalità, qualità: tutto deve essere perfettamente equilibrato per rendere una penna degna di sposarsi ad un'immagine aziendale unica e speciale.

**EN** The design of our pens is the outcome of ongoing styling research: the lines and colours are inspired by the trends of the day. A promotional pen must attract and excite, as well as being a quality support for the message it is delegated to convey. Appearance, originality, quality: everything must be perfectly balanced to make a pen worthy to carry a uniquely special company image.

## Qualità

### *Quality*

**IT** La cura della qualità comincia dalla severa selezione delle materie prime: la plastica, i refill e le molle interne provengono esclusivamente da fornitori italiani o tedeschi, che possono garantirne la qualità e l'affidabilità. La plastica è ottenuta con ABS di prima qualità, atossico, altamente resistente ad urti e sbalzi termici, garanzia di eccellente lucentezza e stabilità del colore. I refill sono conformi alle Direttive della Comunità Europea in materia di sostanze pericolose (2004/73/EC, 67/548/EEC, 2006/1907/EC-REACH) e al TSCA (Toxic Substances Control Act) americano, in quanto contengono inchiostri atossici.

**EN** Attention to quality starts with the strict selection of raw materials: the plastic, refills and inner springs come exclusively from Italian or German suppliers, who guarantee their quality and reliability. The plastic for our pens comes from top quality, non-toxic ABS, which is highly resistant to knocks and sudden changes in temperature, guaranteeing excellent glossiness and high colour stability. The refills respect EU Directives for hazardous substances (2004/73/EC, 67/548/EEC and 2006/1907/EC-REACH) and the American TSCA (Toxic Substances Control Act): so all the inks are non-toxic.

---

## Produzione

### *Production*

**IT** Le nostre linee di montaggio ad elevata automazione assicurano tempi di produzione rapidi e altamente competitivi: a seconda del modello, i macchinari possono montare da 2.000 a 6.000 pezzi l'ora. Automazione significa anche garanzia di funzionalità: rigorosi controlli qualitativi verificano ad ogni fase del montaggio il perfetto funzionamento di ogni penna.

**EN** Our highly automated assembly lines guarantee rapid, extremely competitive manufacturing times: depending on the model, our machinery can assemble from 2,000 to 6,000 pcs per hour. Automation also means guaranteeing functionality: strict quality checks make sure that all our pens operate perfectly at each stage of their assembly.

## Sostenibilità

### *Sustainability*

**IT** Solo una penna di qualità valorizza ogni messaggio, aumenta la visibilità di un marchio e contribuisce a limitare l'inquinamento del pianeta. La plastica inquina: se una penna è di qualità, avrà una vita mediamente lunga che la porterà a passare più volte di mano in mano, contenendo gli sprechi che derivano dall'immediata eliminazione di penne difettose. Meglio investire in penne di qualità, magari riducendone la quantità, piuttosto che rischiare di compromettere la propria immagine e diffondere un uso poco responsabile delle penne in plastica. Più lunga è la vita di una penna, meno si inquina l'ambiente.

**EN** Only a quality pen can really enhance a message, growing a brand's visibility and, why not, helping to limit the pollution of the planet. Plastics pollute: if a pen is high quality it will have a long average lifespan that will lead it to change hands more than once, so limiting the waste that comes from the immediate discarding of faulty pens. It is much better to invest in quality pens, maybe choosing to limit the quantity rather than running the risk of compromising your image and spreading the irresponsible use of plastic pens. The longer a pen's life is, the less it pollutes the environment.

---

## Personalizzazione

### *Customisation*

**IT** Una volta montata, la penna è pronta per essere “vestita” con un marchio o un messaggio: il nostro studio grafico elabora simulazioni digitali per valutare le possibili alternative e suggerisce nuove proposte per arrivare all'abbinamento più adatto. Proprio come in una sartoria si provano misure, colori e posizioni diverse finché l'abito si adatta perfettamente alle forme del cliente. Solo allora comincia la fase di stampa, tampografica o serigrafica, che avviene con l'utilizzo di vernici ad alta tenuta, al termine della quale la penna è finalmente pronta per portare il suo messaggio prezioso: la vostra immagine.

**EN** Once assembled, the pen is ready to be “dressed” with a logo or a message: our graphics office works on digital simulations to assess the possible alternatives, suggesting new proposals so that the most suitable combination can be found. Like a tailor's shop, the customer can try different sizes, colours and positions until the suit adapts perfectly to his needs. Only then does the pad or silk-screen printing stage begin, using highly resistant paints, after which the pen is finally ready to travel the world with its precious message: your image.

## Responsabilità

### *Responsibility*

**IT** La certificazione di provenienza esclusivamente italiana garantisce che i nostri articoli da scrittura non provengano da sfruttamento di manodopera minorile o da condizioni lavorative in contrasto con il rispetto dei diritti fondamentali dei lavoratori. Chiediamo la stessa garanzia anche ai nostri fornitori italiani e tedeschi di materie prime. Anche la scelta di una penna può contribuire a diffondere la cultura e il rispetto della dignità dei lavoratori.

**EN** The certificate of origin for our pens also guarantees that no child labour is involved in their manufacture, nor working conditions that do not respect workers' basic rights. We demand the same guarantee from our Italian and German raw materials suppliers. Even a pen can help to spread the culture and respect of the dignity of workers.

---

# Mood

il design incontra il metallo  
*design with a metal touch*

NEW



**Il lusso  
è un'attitudine.**

*Luxury is a state of mind.*

## Mood

# informazioni tecniche

### technical information

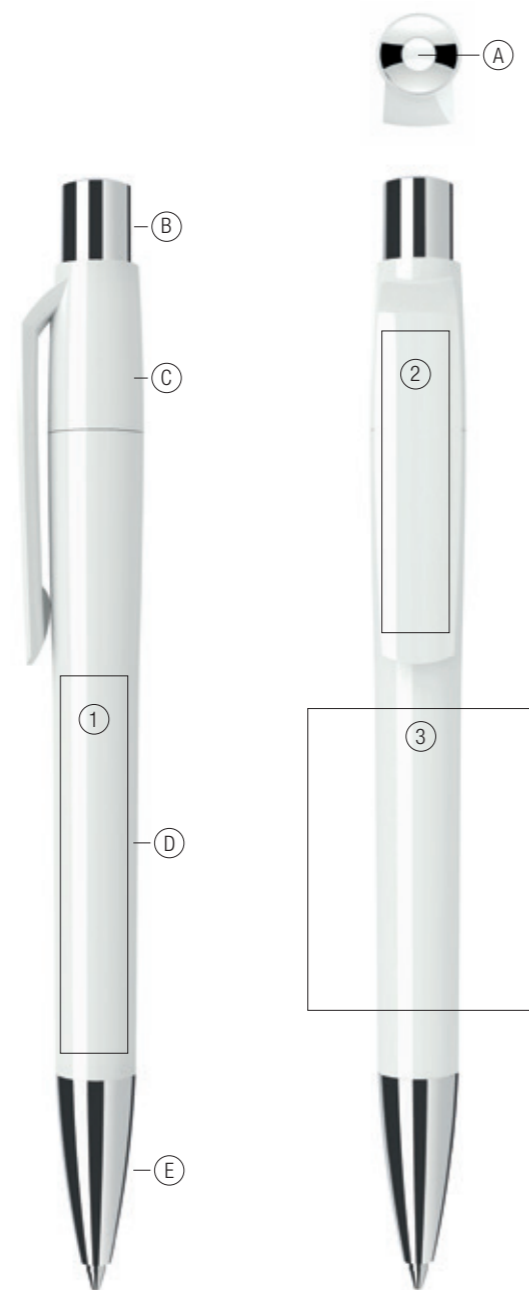

- |                 |                 |
|-----------------|-----------------|
| Ⓐ piccola sfera | Ⓐ little sphere |
| Ⓑ tappino       | Ⓑ push-button   |
| Ⓒ clip          | Ⓒ clip          |
| Ⓓ fusto         | Ⓓ barrel        |
| Ⓔ punta         | Ⓔ tip           |

È possibile combinare particolari di colori diversi della stessa versione (o codice), oppure abbinare elementi di versioni differenti.

You can combine differently coloured parts from the same version (or code number), or elements from different versions.

1/6

### CARATTERISTICHE

- meccanismo a scatto, con molla di ritorno
- realizzata in plastica ABS atossica e ad alta resistenza
- tappino e punta in metallo, lavorati singolarmente con finitura a specchio diamantata
- refill "tipo Parker", inchiostro blu e nero
- disponibile con superfici lucide o gommate
- le versioni con fusto gommato sono stampabili solo su clip

### FEATURES

- retractable with return spring
- made of non-toxic, highly resistant ABS plastic
- metal tip and push-button, individually processed with diamond mirror face finish
- "Parker type" refill, blue and black ink
- available in glossy or rubberised finish
- rubberised barrel versions are only printable on the clip

2/6

### AREA STAMPABILE

- 1 tampografia 45 x 9 mm
- 2 tampografia 40 x 9 mm
- 3 serigrafia 40 x 30 mm

### PRINT AREA

- 1 pad printing 45 x 9 mm
- 2 pad printing 40 x 9 mm
- 3 screen printing 40 x 30 mm

3/6

### TAPPINO E PUNTA

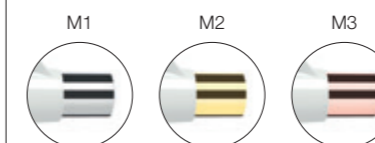

4/6

### FUSTO

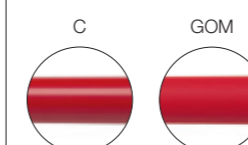

5/6

### CLIP

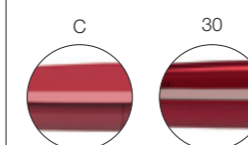

6/6

### COLORAZIONI

- coprenti
  - 01 70 03 18 15 74 60 61 71
- trasparenti
  - 39 52 53 45 59 41 31 55 37
- finiture metallo
  - ● ●

### COLOURS

- solid
  - 25 72 73 79 09 75 26 27 64 77 12 22 05 04
- transparent
  - 38 78 49 47 34 67 44 30 50
- metal finishes



## Mood

# MD1 – C M1

colori coprenti con finitura lucida, punta  
e tappino in metallo con finitura cromata  
solid colours with glossy finish, chrome finish  
metal tip and push-button

NEW



01

70

03

18

15



60

61

71

25

72

74 bordeaux / tampografia 40 x 9 mm  
74 burgundy / pad printing 40 x 9 mm



73

79

09

75

26



64

77

12

22

05

04

27 ottanio / tampografia 40 x 9 mm  
27 octan green / pad printing 40 x 9 mm



## Mood

# MD1 – GOM CB M1

fusto in colore coprente gommato, clip in colore bianco lucido,  
punta e tappino in metallo con finitura cromata  
solid colour barrel with rubber finish, solid glossy white colour clip,  
chrome finish metal tip and push-button

NEW



## Eccellenti materiali plastici e preziosi dettagli in metallo.

*Excellent plastics and precious  
details in metal.*

75 verde scuro / tampografia 40 x 9 mm  
75 dark green / pad printing 40 x 9 mm



## Mood

# MD1 – GOM C M1

fusto in colore coprente gommato, clip in colore coprente  
con finitura lucida, punta e tappino in metallo con finitura cromata  
solid colour barrel with rubber finish, solid colour clip  
with glossy finish, chrome finish metal tip and push-button

NEW

04 nero / tampografia 40 x 9 mm  
04 black / pad printing 40 x 9 mm



## Mood

# MD1 – GOM 30 M1

fusto in colore coprente gommato, clip in colore trasparente  
con finitura lucida, punta e tappino in metallo con finitura cromata  
solid colour barrel with rubber finish, transparent colour clip  
with glossy finish, chrome finish metal tip and push-button

NEW



31 lilla / tampografia 40 x 9 mm  
31 lilac / pad printing 40 x 9 mm

52 giallo / tampografia 40 x 9 mm  
52 yellow / pad printing 40 x 9 mm

78 lime / tampografia 40 x 9 mm  
78 lime / pad printing 40 x 9 mm

## Risultato di lavorazioni artigiane di qualità superiore.

*Result of superior quality craftsmanship.*

## Mood

### MD1 – C M2

colori coprenti con finitura lucida, punta e tappino in metallo con finitura dorata

solid colours with glossy finish, gold finish metal tip and push-button

NEW

**Finitura a specchio  
diamantata per  
i particolari in metallo.**

*Metal details with diamond mirror finish.*



01

04 nero / tampografia 40 x 9 mm  
04 black / pad printing 40 x 9 mm



## Mood

### MD1 – C M3

colore bianco coprente con finitura lucida, punta e tappino in metallo con finitura oro rosa

solid colours with glossy finish, rose gold finish metal tip and push-button

NEW

**Oro rosa, in linea  
con i trend cromatici  
del momento.**

*Rose gold, in line with the colour trends of the moment.*



01 bianco / tampografia 40 x 9 mm  
01 white / pad printing 40 x 9 mm

---

# Flow Pure

pura ed essenziale  
*free from extra*



**L'essenza  
del design.**

*The essence of design.*

# Flow Pure

informazioni  
tecniche

*technical  
information*

## Tampografia e serigrafia disponibili anche su fusto gommato.

*Pad and screen printing also  
available on rubberised barrel.*

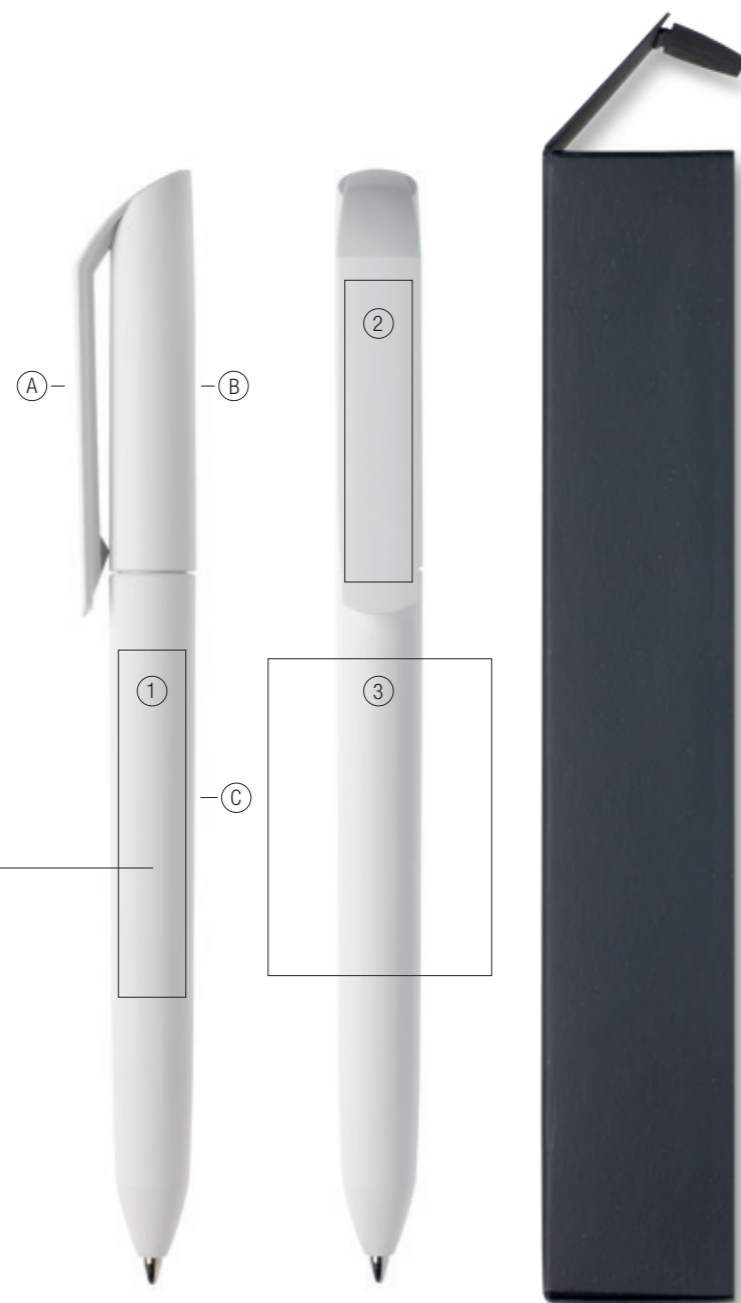

### MY BOX

Astuccio universale  
richiudibile per  
penna singola  
in cartoncino nero  
Fedrigoni.  
Info pag. 229

Universal reclosable  
single pen  
box in Fedrigoni  
black card.  
Info at p. 229

È possibile combinare particolari di colori diversi della stessa versione (o codice), oppure abbinare elementi di versioni differenti.

You can combine differently coloured parts from the same version (or code number), or elements from different versions.

- A** clip
- B** cappuccio
- C** fusto
- A** clip
- B** cap
- C** barrel

1/5

### CARATTERISTICHE

- meccanismo a rotazione
- realizzata in plastica ABS, atossica e ad alta resistenza
- refill Jumbo, inchiostro blu e nero
- disponibile con superfici lucide, satinare o gommate

### FEATURES

- twist-action
- made of non-toxic highly resistant ABS plastic
- Jumbo refill, blue and black ink
- available in glossy, matt or rubberised finish

2/5

### AREA STAMPABILE

- 1 tampografia 50 x 9 mm
- 2 tampografia 40 x 9 mm
- 3 serigrafia 45 x 30 mm

### PRINT AREA

- 1 pad printing 50 x 9 mm
- 2 pad printing 40 x 9 mm
- 3 screen printing 45 x 30 mm

3/5

### FUSTO E CAPPUCCIO

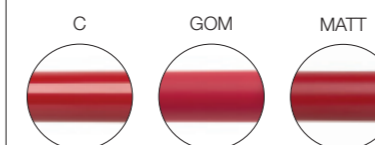

### BARREL AND CAP

4/5

### CLIP

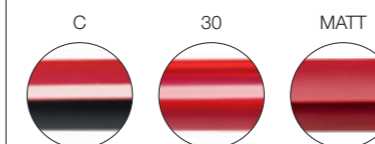

### CLIP

5/5

### COLORAZIONI

- coprenti



- trasparenti



- fluo coprenti



- fluo trasparenti



### COLOURS

- solid



- transparent



- solid fluo

- transparent fluo

# Flow Pure F2 P – MATT B

fusto e cappuccio in colore bianco coprente,  
clip in colore coprente, finiture satinare  
solid white colour barrel and cap,  
solid colour clip, matt finishes



15 rosso / tampografia 40 x 9 mm  
15 red / pad printing 40 x 9 mm  
—  
tampografia 50 x 9 mm  
pad printing 50 x 9 mm



**Satinata ed elegante:  
finitura matt su fusto,  
cappuccio e clip.**

*Satin finish and elegant: this is the  
matt finish on barrel, cap and clip.*

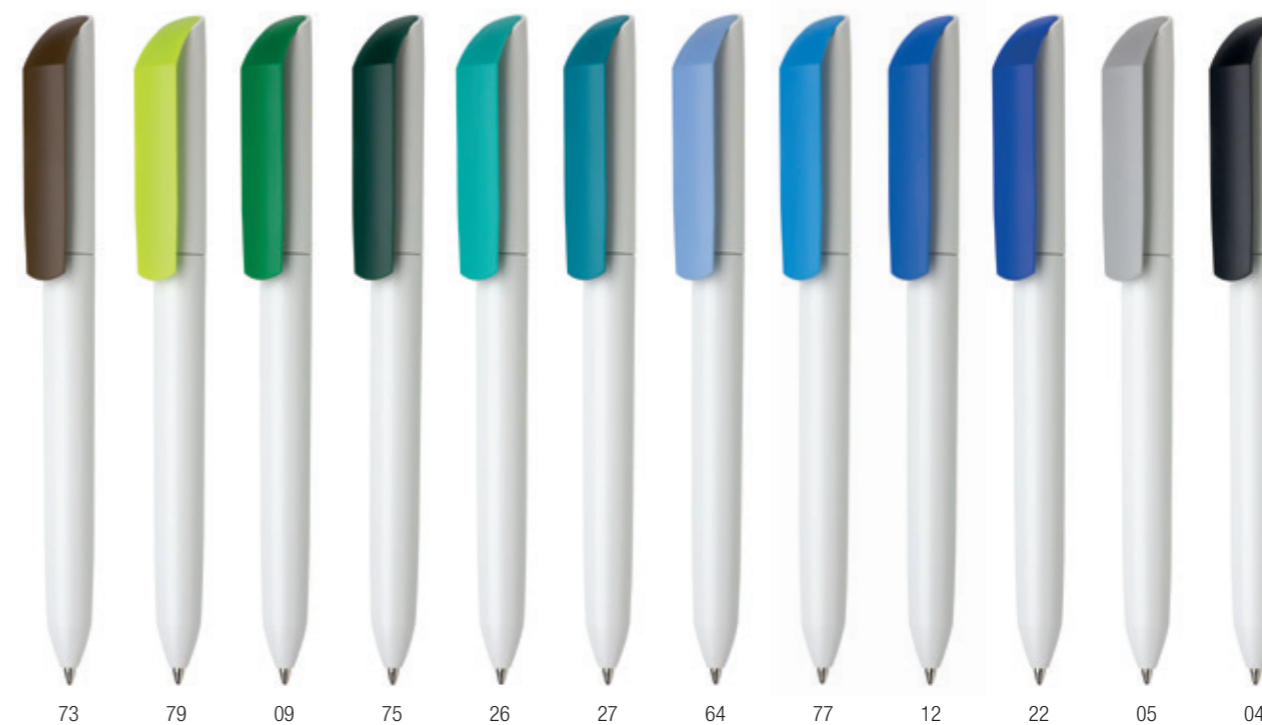



# Flow Pure F2 P – MATT CB

fusto e cappuccio in colore coprente,  
clip in colore bianco coprente, finiture satinare  
solid colour barrel and cap, solid white  
colour clip, matt finishes



## Finitura matt e clip bianca per la massima libertà di personalizzazione.

*Matt finish and white clip for maximum  
freedom of personalisation.*

tampografia 40 x 9 mm  
pad printing 40 x 9 mm

—  
05 grigio / tampografia 50 x 9 mm  
05 grey / pad printing 50 x 9 mm

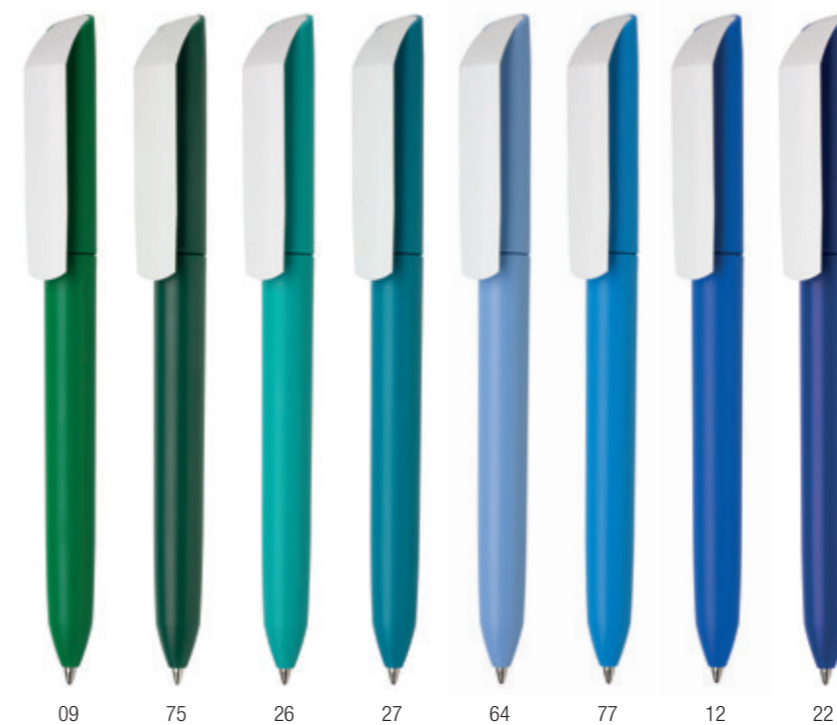

# Flow Pure F2 P – MATT

colori coprenti con finitura satinata  
solid colours with matt finish



71 viola chiaro / tampografia 40 x 9 mm  
71 light violet / pad printing 40 x 9 mm

# Tutta la forza espressiva del colore in versione monocromatica.

*All the expressive force of colour  
in a monochrome version.*

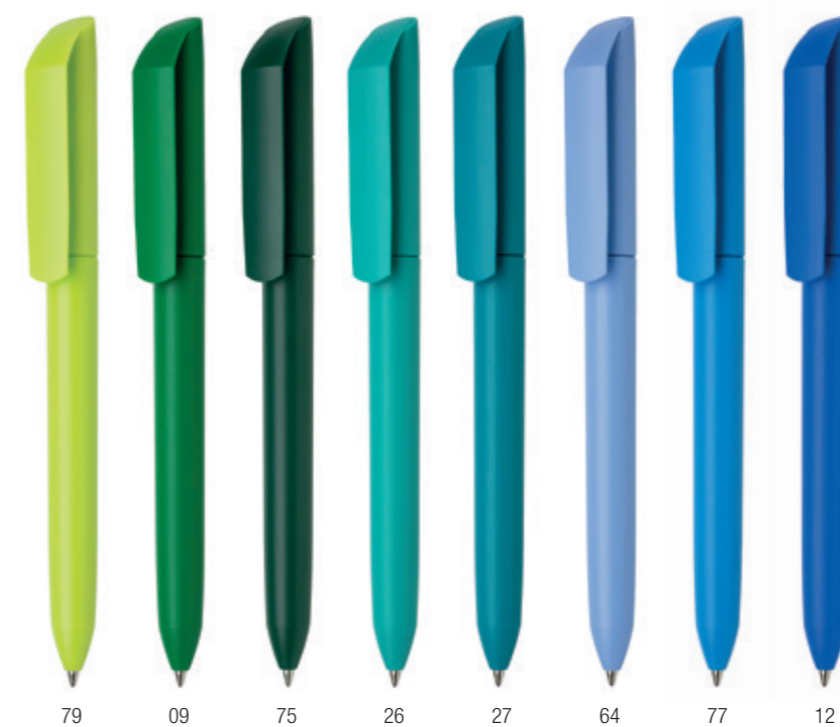

22 blu / tampografia 40 x 9 mm  
22 blue / pad printing 40 x 9 mm



# Flow Pure F2 P – MATT F

colori fluo coprenti con finitura satinata  
solid fluo colours with matt finish

**fluo  
colors**



02



17 arancio / tampografia 40 x 9 mm  
17 orange / pad printing 40 x 9 mm



14

**fluo  
colors**

**La finitura satinata  
si accende  
con i colori fluo.**

*The matt finish lights up with  
fluo colours.*

56 fucsia / tampografia 40 x 9 mm  
56 fuchsia / pad printing 40 x 9 mm



08

# Flow Pure F2 P – C

colori coprenti con finitura lucida  
solid colours with glossy finish



60 rosa / tampografia 40 x 9 mm  
60 pink / pad printing 40 x 9 mm



**Il design è valorizzato  
dalla versione monocromatica  
e i colori risaltano grazie alla  
brillantezza della finitura lucida.**

*The design is enhanced by the monochrome  
version and the colours stand out due to the **brilliance**  
of the gloss finish.*

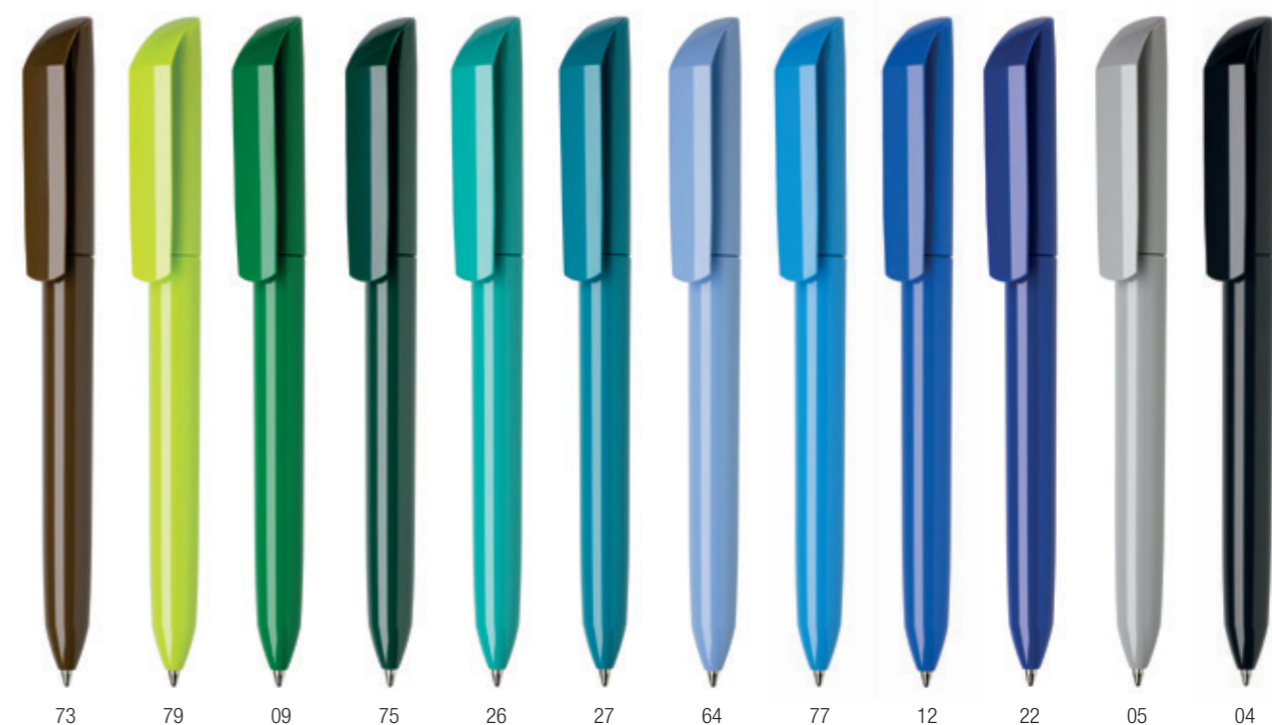

## Flow Pure

# F2 P – B 30

fusto e cappuccio in colore bianco coprente,  
clip in colore trasparente, finiture lucide  
solid white colour barrel and cap, transparent  
colour clip, glossy finishes



51 viola / tampografia 40 x 9 mm  
51 violet / pad printing 40 x 9 mm



**Qualità e lucentezza  
delle superfici catturano  
l'attenzione con colori brillanti  
e particolari trasparenti.**

*Surface quality and gloss capture the attention  
with brilliant colours and transparent details.*

78 lime / tampografia 40 x 9 mm  
78 lime / pad printing 40 x 9 mm



## Flow Pure

# F2 P – GOM K

fusto e cappuccio in colore nero coprente gommato,  
clip in colore coprente lucido  
solid black barrel and cap with rubber finish,  
solid colour clip with glossy finish



70 crema / tampografia 40 x 9 mm  
70 cream / pad printing 40 x 9 mm



03



18 arancio / tampografia 40 x 9 mm  
18 orange / pad printing 40 x 9 mm



15



60



61



71



72



79



09



26 acquamarina / tampografia 40 x 9 mm  
26 aquamarine / pad printing 40 x 9 mm



27



64



77



12



05



04

**Il nero è il nuovo  
protagonista, in abbinamento  
con i colori coprenti.**

*Black in combination with solid  
colours is the new highlight.*

# Flow Pure

## F2 P – GOM CB

fusto e cappuccio in colore coprente gommato,  
clip in colore bianco coprente lucido  
solid colour barrel and cap with rubber finish,  
solid white colour clip with glossy finish

71 viola chiaro / tampografia 40 x 9 mm  
71 light violet / pad printing 40 x 9 mm

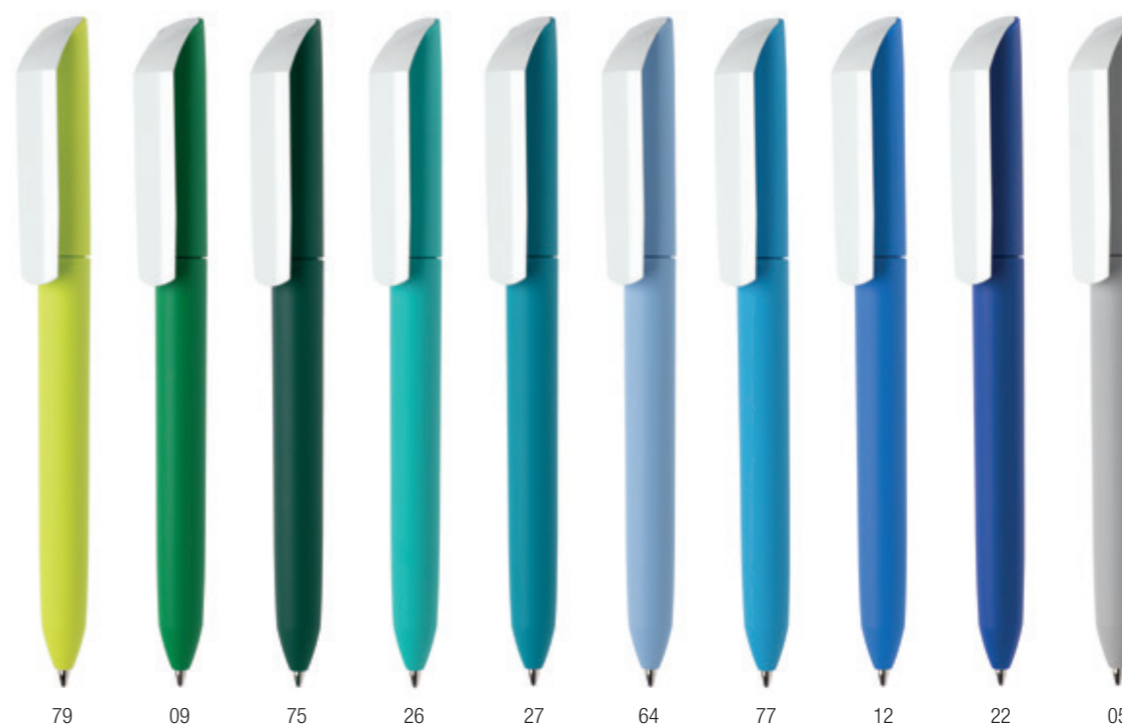

04 nero / tampografia 40 x 9 mm  
04 black / pad printing 40 x 9 mm



**Gommatura integrale:**  
**fusto e cappuccio soft touch.**

*Rubberised all over:*  
*soft touch barrel and cap.*

60 rosa / tampografia 40 x 9 mm  
60 pink / pad printing 40 x 9 mm

# Flow Pure F2 P – GOM 30

fusto e cappuccio in colore coprente gommato,  
clip in colore trasparente lucido  
solid colour barrel and cap with rubber finish,  
transparent colour clip with glossy finish

38 marrone / tampografia 40 x 9 mm  
38 brown / pad printing 40 x 9 mm



**Anche il fusto  
è stampabile  
con tampografia  
o serigrafia!**

*Even the rubberised barrel  
can be pad or silk-screen printed!*

50 grigio scuro / tampografia 40 x 9 mm  
50 dark grey / pad printing 40 x 9 mm



49 verde / tampografia 50 x 9 mm  
49 green / pad printing 50 x 9 mm





## Flow Pure F2 P – GOM CF

fusto e cappuccio in colore fluo coprente gommato,  
clip in colore fluo coprente lucido  
solid fluo colour barrel and cap with rubber finish,  
solid fluo colour clip with glossy finish

**fluo  
colors**



56 fucsia / tampografia 40 x 9 mm  
56 fuchsia / pad printing 40 x 9 mm



08



02



17



14

## Flow Pure F2 P – GOM KF

fusto e cappuccio in colore nero coprente gommato,  
clip in colore fluo coprente lucido  
solid black barrel and cap with rubber finish,  
solid fluo colour clip with glossy finish

**fluo  
colors**



02 giallo / tampografia 40 x 9 mm  
02 yellow / pad printing 40 x 9 mm



17



14 rosso corallo / tampografia 40 x 9 mm  
14 coral red / pad printing 40 x 9 mm



56



08

## Flow Pure

# F2 P – GOM 30 F

fusto e cappuccio in colore fluo coprente gommato,  
clip in colore fluo trasparente lucido  
solid fluo colour barrel and cap with rubber finish,  
transparent fluo colour clip with glossy finish

**fluo  
colors**



20



33 arancio / tampografia 40 x 9 mm  
33 orange / pad printing 40 x 9 mm



24



46



### MY CASE

Astuccio universale  
per penna singola  
in cartoncino nero  
Fedrigoni.  
Info pag. 228

Universal single  
pen box in Fedrigoni  
black card.  
Info at p. 228



48 verde / tampografia 40 x 9 mm  
48 green / pad printing 40 x 9 mm

## Profilo minimal e volumi compatti.

*Minimal profile  
and compact volumes.*

---

# Flow

senti il cambiamento  
*feel the change*



**L'evoluzione  
della forma,  
con e senza texture.**

*Evolution of shape,  
with and without texturing.*

**Flow**  
informazioni  
tecniche  
*technical  
information*

**Tampografia  
e serigrafia  
disponibili  
anche su fusto  
gommato.**

*Pad and screen printing also  
available on rubberised barrel.*

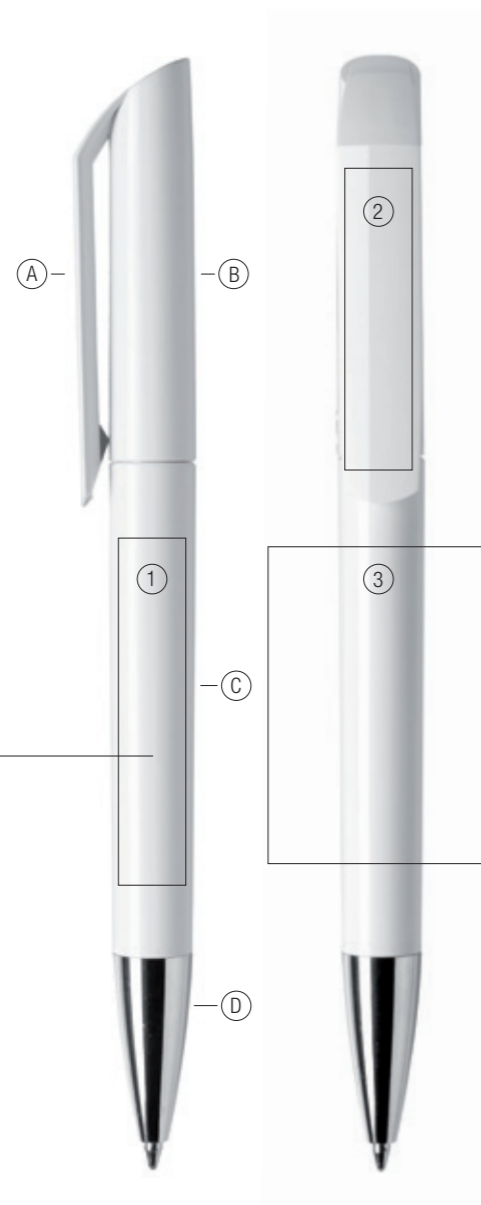

È possibile combinare particolari di colori diversi della stessa versione (o codice), oppure abbinare elementi di versioni differenti.

You can combine differently coloured parts from the same version (or code number), or elements from different versions.

- |             |          |
|-------------|----------|
| Ⓐ clip      | Ⓐ clip   |
| Ⓑ cappuccio | Ⓑ cap    |
| Ⓒ fusto     | Ⓒ barrel |
| Ⓓ punta     | Ⓓ tip    |

1/6

**CARATTERISTICHE**

- meccanismo a rotazione
- realizzata in plastica ABS, atossica e ad alta resistenza
- la cromatura della punta è ottenuta con trattamento galvanico
- refill Jumbo, inchiostro blu e nero
- disponibile con superfici lucide, satinata o gommata
- nella versione Texture il cappuccio satinato è percorso interamente da una trama a nido d'ape

**FEATURES**

- twist-action
- made of non-toxic highly resistant ABS plastic
- galvanic process used to chrome tip
- Jumbo refill, blue and black ink
- available in glossy, matt or rubberised finish
- in the Texture version, the entire matt cap features a honeycomb design

2/6

**AREA STAMPABILE**

- 1 tampografia 46 x 9 mm
- 2 tampografia 40 x 9 mm
- 3 serigrafia 42 x 30 mm

**PRINT AREA**

- 1 pad printing 46 x 9 mm
- 2 pad printing 40 x 9 mm
- 3 screen printing 42 x 30 mm

3/6

**FUSTO**

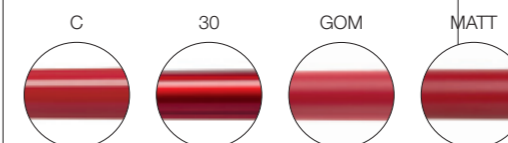

**BARREL**

4/6

**CAPPUCCIO**

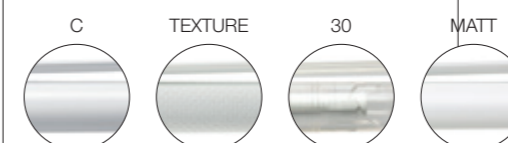

**CAP**

5/6

**PUNTA**

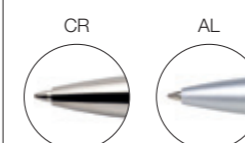

**TIP**

6/6

**COLORAZIONI**

- coprenti
- trasparenti
- trattamento galvanico



**COLOURS**

- solid
- transparent
- galvanic process

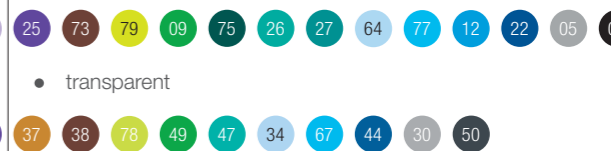

## Flow

# F1 – MATT AL

colori coprenti con finitura satinata, punta verniciata  
in colore alluminio  
solid colours with matt finish, aluminium painted finish tip

NEW



01 70 03 18 15 74 60 61 71 25 73

## Colori matt e punta color alluminio: **eleganza** in versione satinata.

*Matt colours and aluminium  
color tip: **satin style elegance.***



09 75 26 27 64



77 ciano / tampografia 40 x 9 mm  
77 cyan / pad printing 40 x 9 mm

79 lime / tampografia 40 x 9 mm  
79 lime / pad printing 40 x 9 mm

## Flow

# F1 – B 30 CR

fusto e cappuccio in colore bianco coprente lucido,  
clip in colore trasparente con finitura lucida, punta cromata  
solid white barrel and cap with glossy finish, transparent  
colour clip with glossy finish, chromed tip



**Costante lavoro di ricerca sui materiali e il design, in linea con le tendenze del momento, per offrire una penna che sappia enfatizzare l'immagine dell'azienda che ospita.**

*Continuing research into materials and design geared to the latest trends for a pen that is sure to project a high-profile company image.*



50 grigio scuro / tampografia 40 x 9 mm  
50 dark grey / pad printing 40 x 9 mm



# Flow

## F1 – C CR

colori coprenti con finitura lucida, punta cromata  
solid colours with glossy finish, chromed tip



01 bianco / tampografia 40 x 9 mm  
01 white / pad printing 40 x 9 mm



70 03 18 15 74 60 61 71 25 73



79 09 75 26 27 64



77 ciano / tampografia 40 x 9 mm  
77 cyan / pad printing 40 x 9 mm



12 22 05 04

77 ciano / tampografia 46 x 9 mm  
77 cyan / pad printing 46 x 9 mm

## Flow

# F1 – 30 CR

colori trasparenti con finitura lucida, punta cromata  
transparent colours with glossy finish, chromed tip



52



53



45



59



41



51



31



55



37



38



78



49



47



34



67



30



50

39 neutro / tampografia 40 x 9 mm  
39 neutral / pad printing 40 x 9 mm

44 blu / tampografia 40 x 9 mm  
44 blue / pad printing 40 x 9 mm



**Flow** TEXTURE

# F1 T – GOM C CR

fusto in colore coprente gommato, clip in colore coprente lucido, cappuccio  
texturizzato in colore coprente con finitura satinata, punta cromata  
solid colour barrel with rubber finish, solid colour clip with glossy finish,  
textured solid colour cap with matt finish, chromed tip

18 arancio / tampografia 40 x 9 mm  
18 orange / pad printing 40 x 9 mm



01 70 03



15 74 60 61 71 25 73



79 09 75 26 27 64 77 12 22 05

04 nero / tampografia 40 x 9 mm  
04 black / pad printing 40 x 9 mm

**Elemento distintivo:  
cappuccio arricchito  
da una texture.**

*Distinctive feature: textured cap.*



**Flow** TEXTURE

# F1 T – GOM CB CR

fusto in colore coprente gommato, clip in colore bianco lucido, cappuccio  
texturizzato in colore coprente con finitura satinata, punta cromata  
solid colour barrel with rubber finish, solid glossy white colour clip,  
textured solid colour cap with matt finish, chromed tip

73 marrone / tampografia 40 x 9 mm  
73 brown / pad printing 40 x 9 mm



03 18 15 74 60 61 71 25



79



09 75 27 64 77 12 22

05 grigio / tampografia 40 x 9 mm  
05 grey / pad printing 40 x 9 mm

**Texture costituita da piccole celle esagonali che ricordano un nido d'ape: un design dinamico che dona eleganza visiva e tattile.**

*Textured with small hexagonal cells that recall a honeycomb: a dynamic design of visual and tactile elegance.*

05 grigio / tampografia 40 x 9 mm  
05 grey / pad printing 40 x 9 mm

26 acquamarina / tampografia 40 x 9 mm  
26 aquamarine / pad printing 40 x 9 mm



**Flow** TEXTURE

# F1 T – GOM 30 CR

fusto in colore coprente gommato, clip in colore trasparente lucido,  
cappuccio texturizzato in colore coprente con finitura satinata, punta cromata  
solid colour barrel with rubber finish, transparent glossy colour clip,  
textured solid colour cap with matt finish, chromed tip



39 52 53 45



59 rosa / tampografia 40 x 9 mm  
59 pink / pad printing 40 x 9 mm



41 31 55 37



38 78 49 47



30 grigio chiaro / tampografia 40 x 9 mm  
30 light grey / pad printing 40 x 9 mm



67 44



50

---

# Dot

diversa da tutte, punto  
*different from the rest, full stop*

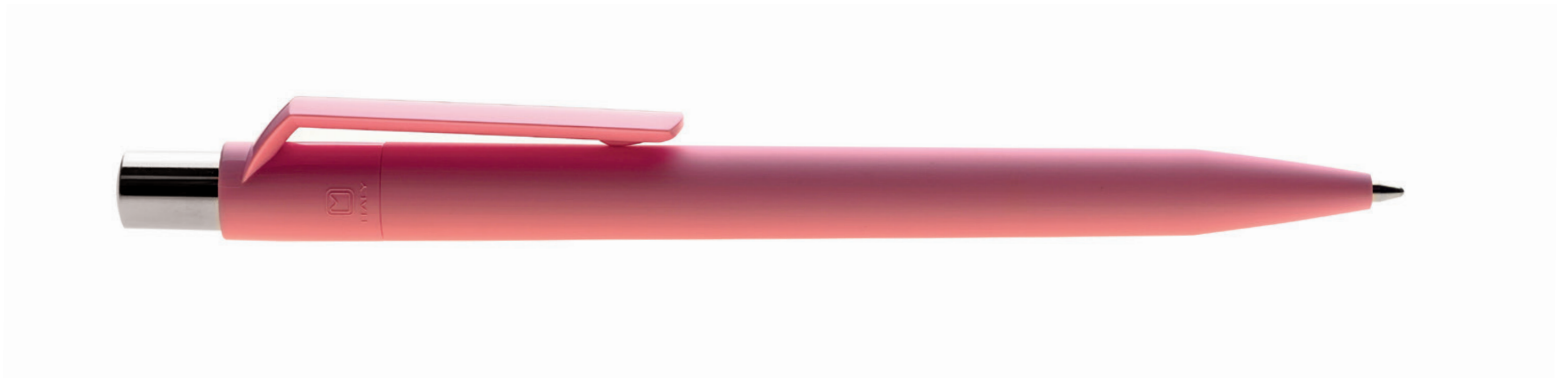

**È nei dettagli  
che rivela  
la sua originalità.**

*A pen that reveals  
its originality in its details.*

**Dot**  
informazioni  
tecniche  
*technical  
information*

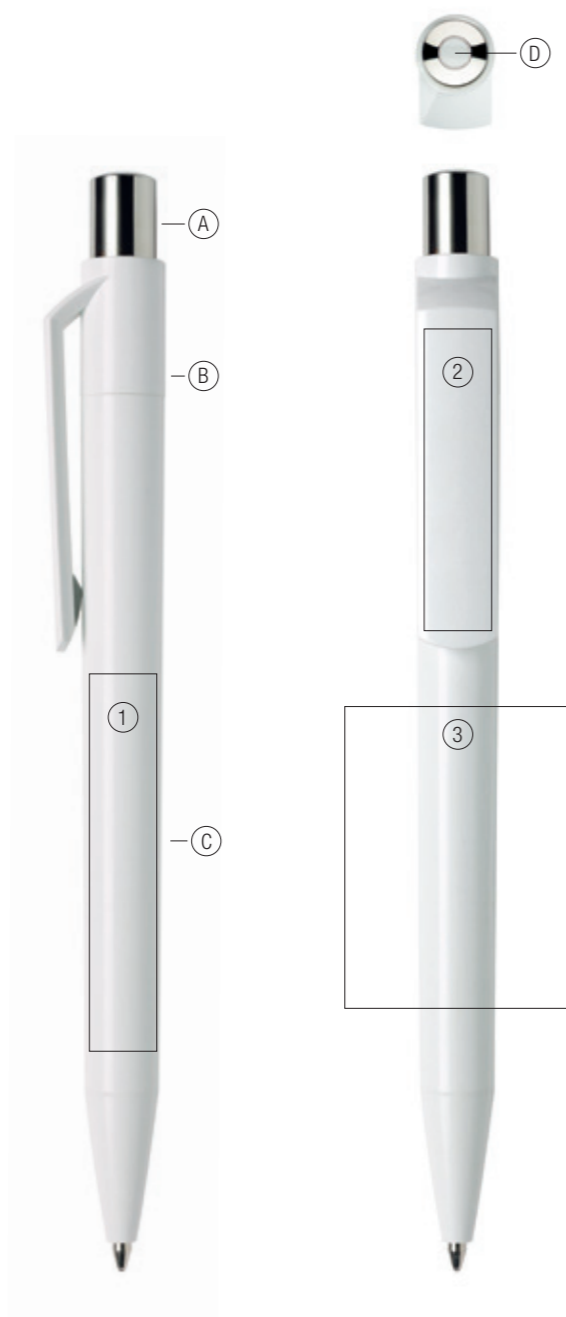

- |                 |                 |
|-----------------|-----------------|
| Ⓐ tappino       | Ⓐ push-button   |
| Ⓑ clip          | Ⓑ clip          |
| Ⓒ fusto         | Ⓒ barrel        |
| Ⓓ piccola sfera | Ⓓ little sphere |

È possibile combinare particolari di colori diversi della stessa versione (o codice), oppure abbinare elementi di versioni differenti.

You can combine differently coloured parts from the same version (or code number), or elements from different versions.

1/5

**CARATTERISTICHE**

- meccanismo a scatto, con molla di ritorno
- realizzata in plastica ABS atossica e ad alta resistenza
- la cromatura e la doratura del tappino sono ottenute con trattamento galvanico
- refill Jumbo, inchiostro blu e nero
- disponibile con superfici lucide, satinare o gommate
- le versioni con fusto gommato sono stampabili solo su clip

**FEATURES**

- retractable with return spring
- made of non-toxic, highly resistant ABS plastic
- galvanic process used to chrome and gold ABS push-button
- Jumbo refill, blue and black ink
- available in glossy, matt or rubberised finish
- rubberised barrel versions are only printable on the clip

2/5

**AREA STAMPABILE**

- ① tampografia 50 x 9 mm
- ② tampografia 40 x 9 mm
- ③ serigrafia 40 x 30 mm

**PRINT AREA**

- ① pad printing 50 x 9 mm
- ② pad printing 40 x 9 mm
- ③ screen printing 40 x 30 mm

3/5

**FUSTO**

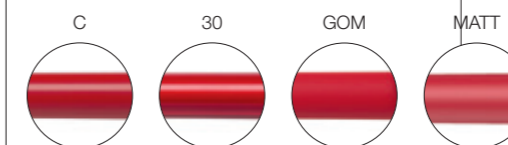

**BARREL**

4/5

**TAPPINO**

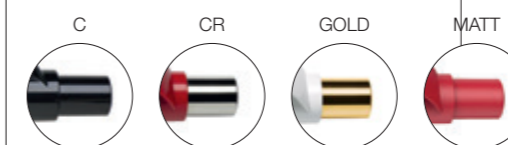

**PUSH-BUTTON**

5/5

**COLORAZIONI**

- coprenti
  - 01 70 03 18 15 74 60 61 71
- trasparenti
  - 39 52 53 45 59 41 31 55 37
- fluo coprenti
  - 02 17 14 56 08
- fluo trasparenti
  - 20 33 24 46 48
- trattamento galvanico

**COLOURS**

- solid
  - 25 72 73 79 09 75 26 27 64 77 12 22 05 04
- transparent
  - 38 78 49 47 34 67 44 30 50
- solid fluo
- transparent fluo
- galvanic process



## Dot

# D1 – MATT B

fusto, clip e tappino in colore bianco coprente con  
finitura satinata, piccola sfera in colore coprente lucido  
solid white colour barrel, clip and push-button with matt  
finish, solid glossy colour little sphere

NEW

**La finitura satinata  
esalta il design  
e offre nuove  
sensazioni tattili.**

*The matt finish enhances the design  
and offers new tactile sensations.*



03 giallo / tampografia 40 x 9 mm  
03 yellow / pad printing 40 x 9 mm



18



15



74



60



61



71



25



73



79



09

Il punto di colore spicca  
nella nitidezza del bianco.

*The touch of colour stands out against the pure white.*



75



26



27



64



77



12



22



05



04

# Dot

## D1 – MATT CB

fusto in colore coprente con finitura satinata, clip e tappino in colore bianco coprente satinato, piccola sfera in colore coprente lucido  
solid colour barrel with matt finish, solid matt white clip and push-button, solid glossy colour little sphere

NEW



03

18

15

74



61

71

25

73

60 rosa / tampografia 40 x 9 mm  
60 pink / pad printing 40 x 9 mm



79

09

75

26

27

64

77

12 azzurro / tampografia 40 x 9 mm  
12 light blue / pad printing 40 x 9 mm



22

05

04

## Dot

# D1 – MATT

colori coprenti con finitura satinata, piccola sfera  
in colore coprente lucido  
solid colours with matt finish, solid glossy colour  
little sphere

NEW



71 viola chiaro / tampografia 40 x 9 mm  
71 light violet / pad printing 40 x 9 mm



## Attraiante e raffinata: è la nuova finitura satinata integrale.

*Attractive and refined: the new integral matt finish.*

04 nero / tampografia 40 x 9 mm  
04 black / pad printing 40 x 9 mm

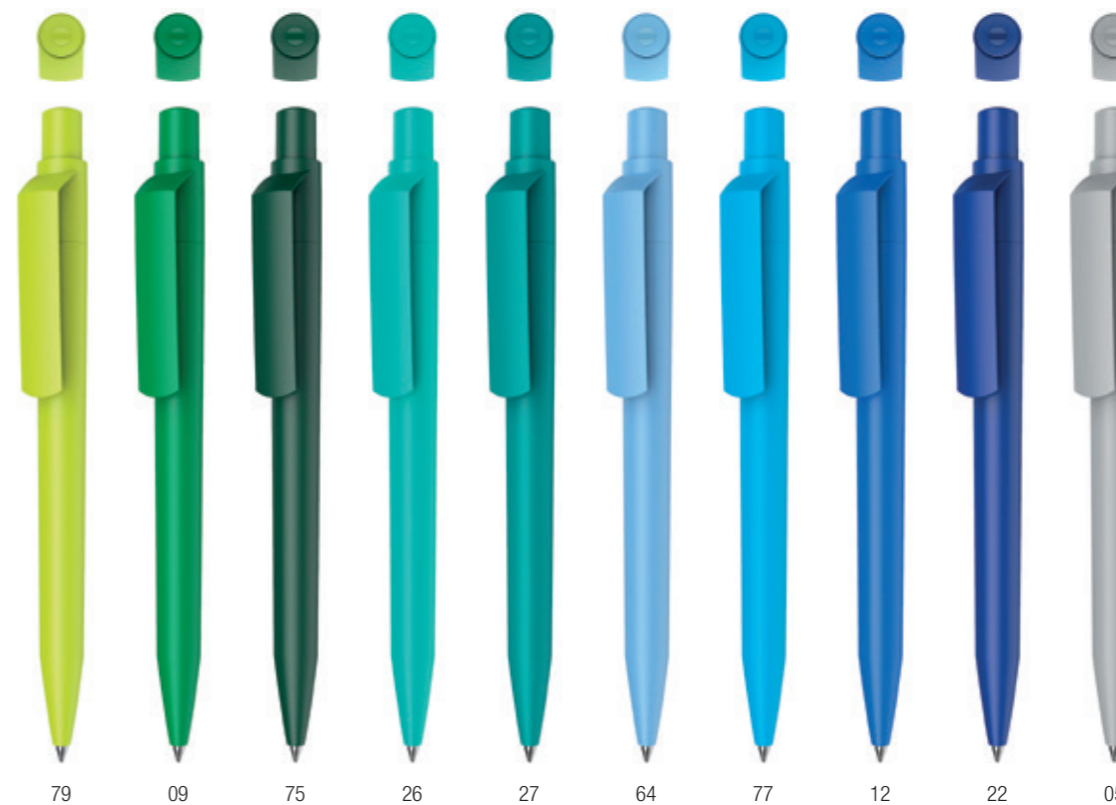



## Dot

# D1 – MATT K

fusto, clip e tappino in colore nero coprente con finitura satinata, piccola sfera in colore coprente lucido  
solid black colour barrel, clip and push-button with matt finish, solid glossy colour little sphere

NEW



**Purezza di linee  
e finitura matt:  
semplicemente  
elegante.**

*Purity of lines and matt finish:  
simply elegant.*



01

70 crema / tampografia 40 x 9 mm  
70 cream / pad printing 40 x 9 mm



03



18



15



74



60



61



71



25



72



73

Il nero minimal è abbinato  
a una piccola e discreta  
nota di colore.

*Minimal black is combined with a discreet touch of colour.*



79



09



75



26



27



77



12



22



05



04

**Dot**

# D1 – MATT F

colori fluo coprenti con finitura satinata, piccola sfera  
in colore fluo coprente lucido  
solid fluo colours with matt finish, solid glossy fluo  
colour little sphere

NEW

**Impatto cromatico  
più incisivo  
grazie ai colori fluo.**

*A more profound chromatic impact  
thanks to the fluo colours.*



**fluo  
colors**



14 rosso corallo / tampografia 40 x 9 mm  
14 coral red / pad printing 40 x 9 mm

## Dot

# D1 – B CR

fusto e clip in colore bianco coprente con finitura lucida,  
piccola sfera in colore coprente lucido, tappino cromato  
solid white colour barrel and clip with glossy finish,  
solid glossy colour little sphere, chromed push-button



**La superficie bianca  
è la base creativa  
per eccellenza: libertà  
di espressione e massima  
resa cromatica.**

*A white surface is the creative foundation  
par excellence: freedom of expression  
and top colour rendering.*



01



03 giallo / tampografia 40 x 9 mm  
03 yellow / pad printing 40 x 9 mm



18



15



74



60



61



71



25



73



79



09

Total white: essenziale ed elegante  
grazie al raffinato dettaglio di colore.

*Total white: basic and elegant thanks  
to its refined color detail.*



75



27



64



77



12



22



05



04

## Dot

### D1 – BC CR

fusto bianco coprente lucido, clip e piccola sfera  
in colore coprente con finitura lucida, tappino cromato  
solid glossy white colour barrel, solid colour clip  
and little sphere with glossy finish, chromed push-button



61 magenta / tampografia 40 x 9 mm  
61 magenta / pad printing 40 x 9 mm



03 18 15 74 60



71 25 72 73



79 09



75 verde scuro / tampografia 40 x 9 mm  
75 dark green / pad printing 40 x 9 mm



27 64 77 12 22



05 grigio / tampografia 40 x 9 mm  
05 grey / pad printing 40 x 9 mm



04

**Estetica della clip  
molto ricercata,  
per far risaltare  
la forza e il carattere  
di ogni brand.**

*The clip is of highly refined appearance to highlight the strength and personality of each brand.*

## Dot

# D1 – B 30 CR

fusto bianco coprente lucido, clip in colore  
trasparente con finitura lucida, piccola sfera  
in colore coprente lucido, tappino cromato  
solid glossy white colour barrel, transparent colour  
clip with glossy finish, solid glossy colour little  
sphere, chromed push-button

**Il meccanismo è a scatto  
con molla di ritorno  
in tutte le combinazioni.**

*Retractable with return spring in all versions.*



55 viola scuro / tampografia 40 x 9 mm  
55 dark violet / pad printing 40 x 9 mm



49 verde / tampografia 40 x 9 mm  
49 green / pad printing 40 x 9 mm



# Dot

## D1 – CB CR

fusto e piccola sfera in colore coprente lucido,  
clip in colore bianco coprente lucido, tappino cromato  
solid colour barrel and little sphere with glossy finish,  
solid glossy white colour clip, chromed push-button



15 rosso / tampografia 40 x 9 mm  
15 red / pad printing 40 x 9 mm



04 nero / tampografia 40 x 9 mm  
04 black / pad printing 40 x 9 mm



# Dot

## D1 – C CR

colori coprenti con finitura lucida, tappino cromato  
solid colours with glossy finish, chromed push-button



18 arancio / tampografia 40 x 9 mm  
18 orange / pad printing 40 x 9 mm

74 bordeaux / tampografia 40 x 9 mm  
74 burgundy / pad printing 40 x 9 mm

64 azzurro pastello / tampografia 40 x 9 mm  
64 pastel blue / pad printing 40 x 9 mm

04 nero / tampografia 40 x 9 mm  
04 black / pad printing 40 x 9 mm

## Dot

# D1 – 30 CR

colori trasparenti con finitura lucida, piccola sfera in colore coprente lucido, tappino cromato  
transparent colours with glossy finish, solid glossy colour little sphere, chromed push-button

**Le componenti di Dot  
si prestano ad originali  
accostamenti cromatici per  
soddisfare ogni esigenza  
di personalizzazione.**

*Dot components permit original colour combinations  
to cater to all personalisation requirements.*



39



53

45

41

55

37

38

52 giallo / tampografia 40 x 9 mm  
52 yellow / pad printing 40 x 9 mm



78 lime / tampografia 40 x 9 mm  
78 lime / pad printing 40 x 9 mm



49

47

67

44

50



## Dot

# D1 – GOM K

fusto in colore nero coprente gommato,  
clip e tappino in colore nero coprente lucido,  
piccola sfera in colore coprente lucido  
solid black colour barrel with rubber finish,  
solid black colour clip and push-button  
with glossy finish, solid glossy colour little sphere



**L'eleganza del nero  
si combina con  
la finitura soft touch  
per un risultato  
di grande impatto.**

*The elegance of black combines with  
a soft touch finish for a high-impact result.*



01



70 crema / tampografia 40 x 9 mm  
70 cream / pad printing 40 x 9 mm



03



18



15



74



60



61



71



25



72



73

Total black  
con nota di colore.

*Total black with a note of colour.*



79



09



75



26



27



77



12



22



05



04

# Dot

## D1 – GOM CB CR

fusto in colore coprente gommato, clip in colore bianco coprente lucido,  
piccola sfera in colore coprente lucido, tappino cromato  
solid colour barrel with rubber finish, solid glossy white colour clip,  
solid glossy colour little sphere, chromed push-button



25 viola scuro / tampografia 40 x 9 mm  
25 dark violet / pad printing 40 x 9 mm

64 azzurro pastello / tampografia 40 x 9 mm  
64 pastel blue / pad printing 40 x 9 mm

18 arancio / tampografia 40 x 9 mm  
18 orange / pad printing 40 x 9 mm

05 grigio / tampografia 40 x 9 mm  
05 grey / pad printing 40 x 9 mm

# Dot D1 – GOM C CR

fusto in colore coprente gommato, clip e piccola sfera  
in colore coprente con finitura lucida, tappino cromato  
solid colour barrel with rubber finish, solid colour clip  
and little sphere with glossy finish, chromed push-button



71 viola chiaro / tampografia 40 x 9 mm  
71 light violet / pad printing 40 x 9 mm



03 giallo / tampografia 40 x 9 mm  
03 yellow / pad printing 40 x 9 mm



22 blu / tampografia 40 x 9 mm  
22 blue / pad printing 40 x 9 mm



# Dot

## D1 – GOM 30 CR

fusto in colore coprente gommato, clip in colore trasparente con finitura lucida, piccola sfera in colore coprente lucido, tappino cromato  
solid colour barrel with rubber finish, transparent colour clip with glossy finish, solid glossy colour little sphere, chromed push-button



38 marrone / tampografia 40 x 9 mm  
38 brown / pad printing 40 x 9 mm



50 grigio scuro / tampografia 40 x 9 mm  
50 dark grey / pad printing 40 x 9 mm

**Dot**  
D1 – C GOLD

colori coprenti con finitura  
lucida, tappino dorato  
solid colours with glossy finish,  
gilded push-button



04

01 bianco / tampografia 40 x 9 mm  
01 white / pad printing 40 x 9 mm

**Dot**  
D1 – GOM CB F CR

fusto in colore fluo coprente gommatto, clip in colore bianco coprente lucido,  
piccola sfera in colore fluo coprente lucido, tappino cromato  
solid fluo colour barrel with rubber finish, solid glossy white colour clip,  
solid glossy fluo colour little sphere, chromed push-button



17

14

56

08

02 giallo / tampografia 40 x 9 mm  
02 yellow / pad printing 40 x 9 mm



**MY BOX**

Astuccio universale  
richiudibile per  
penna singola  
in cartoncino nero  
Fedrigoni.  
Info pag. 229

Universal reclosable  
single pen  
box in Fedrigoni  
black card.  
Info at p. 229

**Dot**  
D1 – GOM KF CR

fusto in colore nero coprente gommato, clip e piccola sfera in colore fluo coprente lucido, tappino cromato  
solid black colour barrel with rubber finish, solid fluo colour clip and little sphere with glossy finish, chromed push-button

**fluo colors**



17 arancio / tampografia 40 x 9 mm  
17 orange / pad printing 40 x 9 mm



02



14 rosso corallo / tampografia 40 x 9 mm  
14 coral red / pad printing 40 x 9 mm



56



08

**Dot**  
D1 – GOM 30 F CR

fusto in colore fluo coprente gommato, clip in colore fluo trasparente lucido, piccola sfera in colore fluo coprente lucido, tappino cromato  
solid fluo colour barrel with rubber finish, transparent glossy fluo colour clip, solid glossy fluo colour little sphere, chromed push-button

**fluo colors**



20



33



24



46

48 verde / tampografia 40 x 9 mm  
48 green / pad printing 40 x 9 mm



---

# Zink

solide geometrie  
*solid geometries*

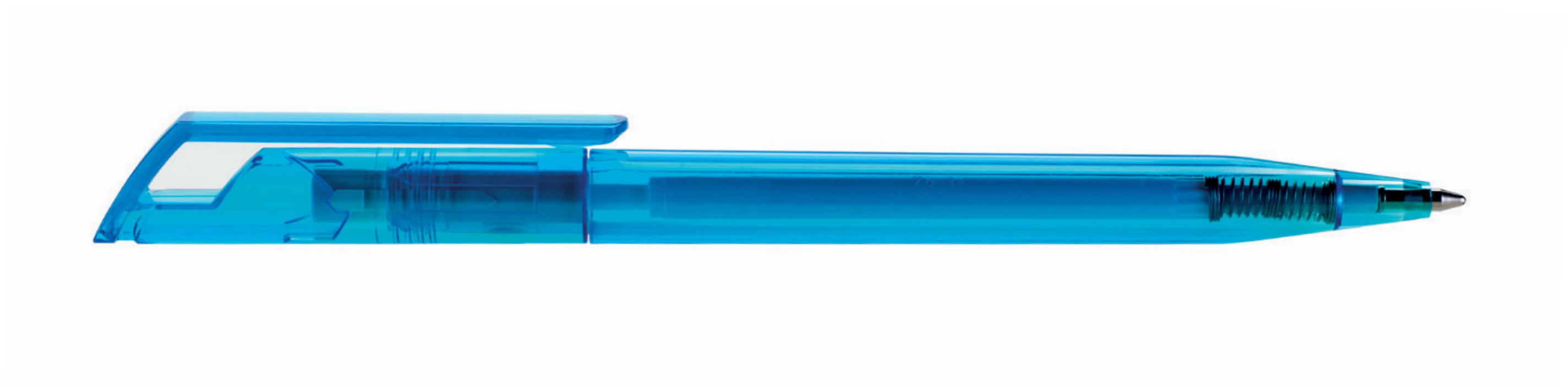

**Una penna  
dal profilo tagliente  
e dal carattere deciso.**

*A pen with a clean-cut profile  
and strong personality.*

# Zink

## informazioni tecniche

*technical information*

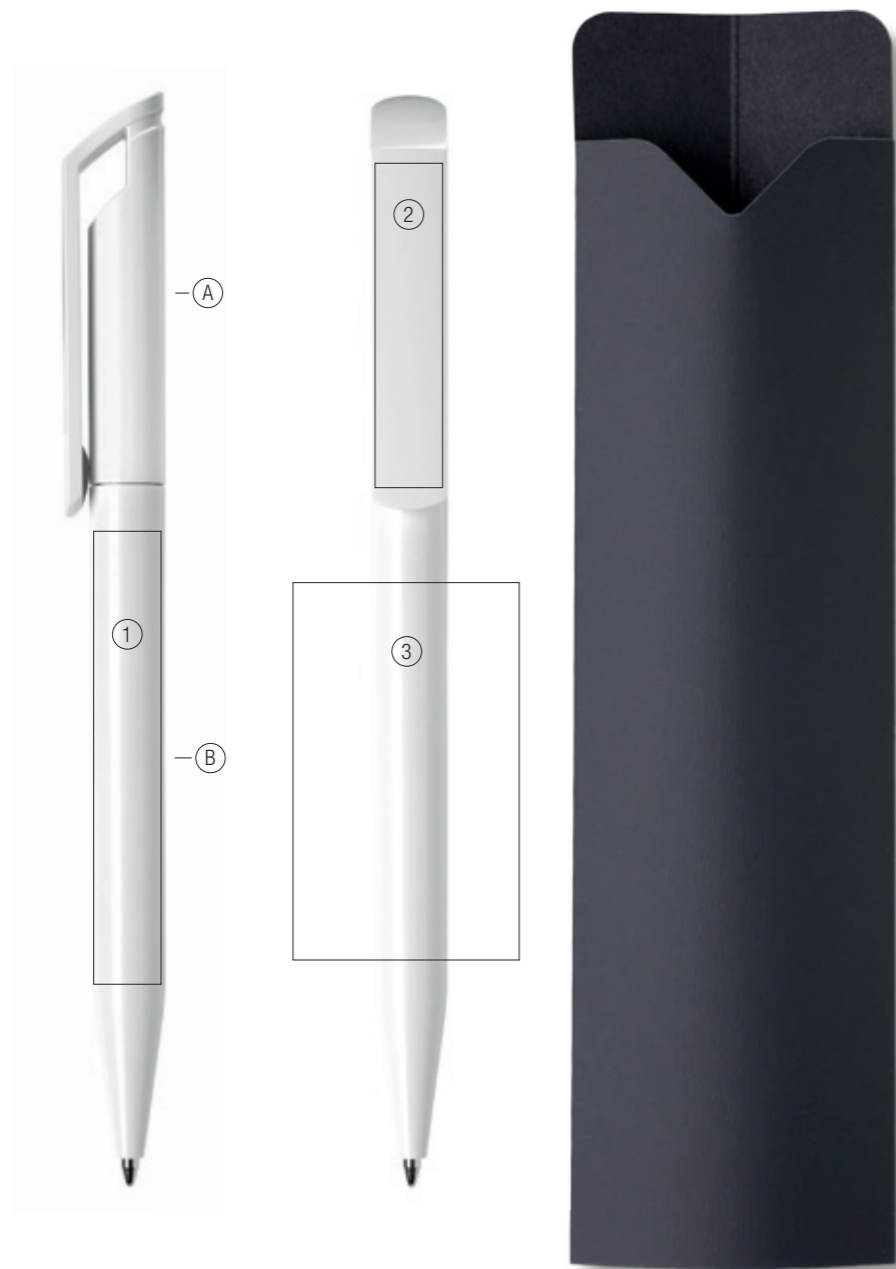

### MY CASE

Astuccio universale per penna singola in cartoncino nero Fedrigoni. Info pag. 228

Universal single pen box in Fedrigoni black card. Info at p. 228

1/5

### CARATTERISTICHE

- meccanismo a rotazione
- realizzata in plastica ABS atossica e ad alta resistenza
- refill Jumbo, inchiostro blu e nero
- disponibile con superfici lucide

### FEATURES

- twist-action
- made of non-toxic, highly resistant ABS plastic
- Jumbo refill, blue and black ink
- available in glossy finish

2/5

### AREA STAMPABILE

- 1 tampografia 60 x 9 mm
- 2 tampografia 43 x 9 mm
- 3 serigrafia 50 x 30 mm

### PRINT AREA

- 1 pad printing 60 x 9 mm
- 2 pad printing 43 x 9 mm
- 3 screen printing 50 x 30 mm

3/5

### FUSTO

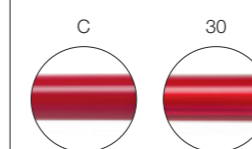

### BARREL

4/5

### CAPPUCCIO

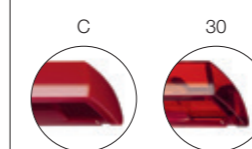

### CAP

5/5

### COLORAZIONI

- coprenti



- trasparenti



- fluo coprenti



### COLOURS

- solid

- transparent

- solid fluo

È possibile combinare particolari di colori diversi della stessa versione (o codice), oppure abbinare elementi di versioni differenti.

You can combine differently coloured parts from the same version (or code number), or elements from different versions.

A cappuccio

A cap

B fusto

B barrel



Zink

Z1 – CB

fusto in colori coprenti, cappuccio in colore  
bianco coprente, finiture lucide  
solid colours barrel, solid white colour cap,  
glossy finishes

NEW

**Nuova versione  
con clip bianca:  
maggiore versatilità  
per la stampa  
a più colori.**

*New version with white clip:  
more suitability for multi-color printing.*



60 rosa / tampografia 43 x 9 mm  
60 pink / pad printing 43 x 9 mm

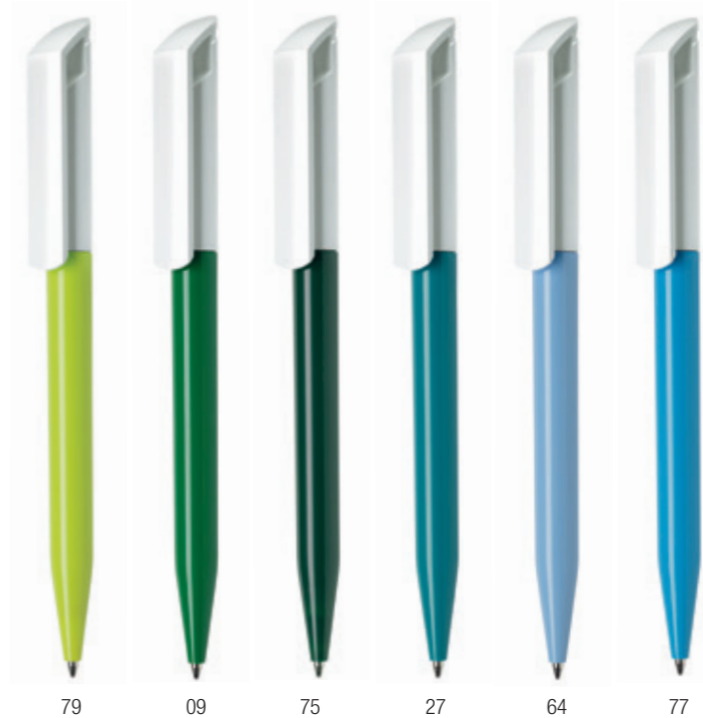

12 azzurro / tampografia 43 x 9 mm  
12 light blue / pad printing 43 x 9 mm

# Zink Z1 - C

colori coprenti con finitura lucida  
solid colours with glossy finish

**Architettura corposa  
e robusta per un profilo  
dal rigore geometrico.**

*Solid, sturdy architecture  
for a profile of geometric precision.*



**Zink**

Z1 – 30

colori trasparenti con finitura lucida  
transparent colours with glossy finish

37 ambra / tampografia 43 x 9 mm  
37 amber / pad printing 43 x 9 mm



39 52 53 45 59 41 51 31 55



67 ciano / tampografia 43 x 9 mm  
67 cyan / pad printing 43 x 9 mm



38 78 49 47



44 30 50

**Il fusto slanciato bilancia  
la solida struttura.**

*Its sturdy structure is offset by  
the slim, streamlined barrel.*

**Zink**  
Z1 – CF

colori fluo coprenti con finitura lucida  
solid fluo colours with glossy finish



02



17 arancio / tampografia 43 x 9 mm  
17 orange / pad printing 43 x 9 mm



14



56

**Colori fluo,  
tonalità intense  
e vibranti.**

*Fluo colours, intense  
and vibrant shades.*



08 verde / tampografia 43 x 9 mm  
08 green / pad printing 43 x 9 mm

---

# View

carattere incisivo  
*decisive personality*



**Sprigiona grinta  
da ogni punto  
di vista e affascina  
per l'eleganza.**

*Exudes boldness from every angle  
and captivates with its elegance.*

**View**  
informazioni  
tecniche  
*technical  
information*

**Soluzioni di  
stampa sulla  
clip in metallo.**

*Print solutions  
for the metal clip.*

- 1 tampografia 40 x 6 mm  
pad printing 40 x 6 mm
- 2 incisione laser 30 x 7 mm  
laser engraving 30 x 7 mm

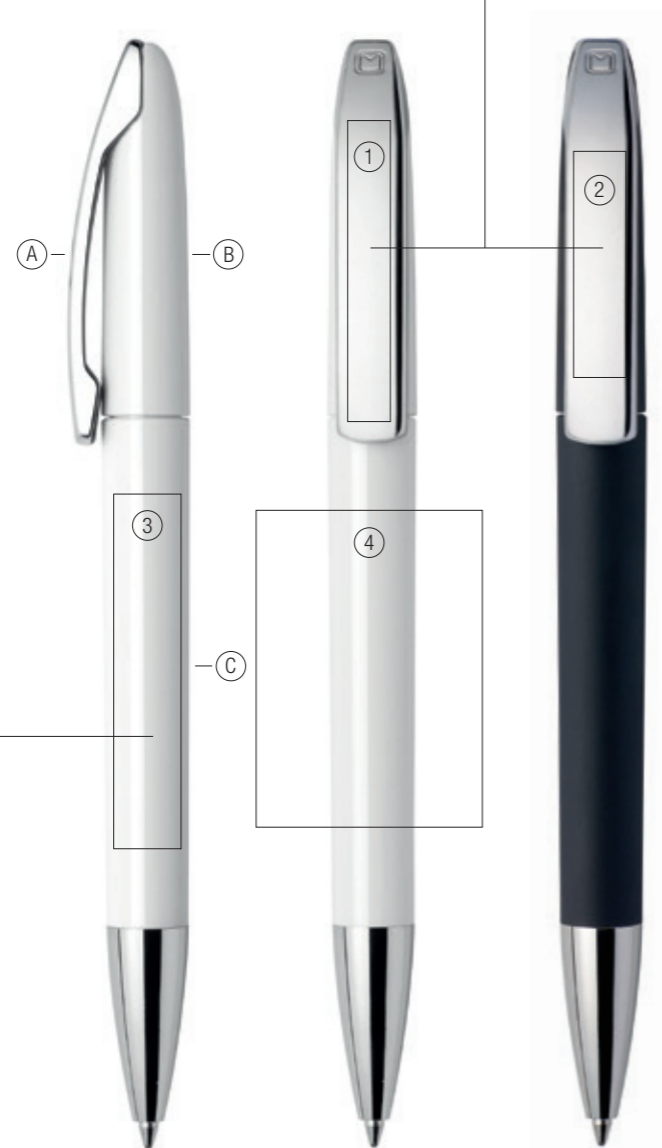

**Tampografia  
e serigrafia  
disponibili  
anche su fusto  
gommato.**

*Pad and screen printing also  
available on rubberised barrel.*

È possibile combinare particolari di colori diversi della stessa versione (o codice), oppure abbinare elementi di versioni differenti.

You can combine differently coloured parts from the same version (or code number), or elements from different versions.

- A clip
- B cappuccio
- C fusto

- A clip
- B cap
- C barrel

**CARATTERISTICHE**

- meccanismo a rotazione
- realizzata in plastica ABS atossica e ad alta resistenza
- clip in metallo cromato, disponibile per incisione laser e tampografia.
- la cromatura della punta è ottenuta con trattamento galvanico
- refill Jumbo, inchiostro blu e nero
- disponibile con superfici lucide, gommate o verniciate in colore alluminio

**FEATURES**

- twist-action
- made of non-toxic, highly resistant ABS plastic
- metal chrome finish clip available for laser engraving and pad printing
- galvanic process used to chrome tip
- Jumbo refill, blue and black ink
- available in glossy, rubberised or aluminium painted finish

**AREA STAMPABILE**

- 3 tampografia 47 x 9 mm
- 4 serigrafia 42 x 30 mm

**PRINT AREA**

- 3 pad printing 47 x 9 mm
- 4 screen printing 42 x 30 mm

**FUSTO**

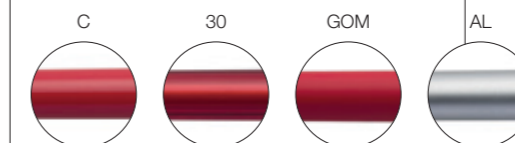

**BARREL**

**PUNTA**

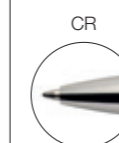

**TIP**

**COLORAZIONI**

- coprenti



- trasparenti



- vernici metallizzate



- trattamento galvanico



**COLOURS**

- solid



- transparent



- metallic paintings

- galvanic process

## View

# V1 – C CR / V1 – C CRT \*

colori coprenti con finitura lucida,  
clip in metallo cromato, punta cromata  
solid colours with glossy finish,  
metal chrome finish clip, chromed tip

**La linea affilata del cappuccio  
dà armonia e bilancia  
l'imponenza della clip.**

*The sleek design of the cap adds elegance  
and balances the large clip.*



60 rosa / incisione laser 30 x 7 mm  
60 pink / laser engraving 30 x 7 mm



22 blu / tampografia su clip 40 x 6 mm  
22 blue / pad printing on the clip 40 x 6 mm



(\*)  
V1 – C CR clip per incisione laser /  
clip for laser engraving  
V1 – C CRT clip per tampografia /  
clip for pad printing

79 lime / serigrafia 42 x 30 mm  
79 lime / screen printing 42 x 30 mm

## View

### V1 – 30 CR / V1 – 30 CR T \*

colori trasparenti con finitura lucida,  
clip in metallo cromato, punta cromata  
transparent colours with glossy finish,  
metal chrome finish clip, chromed tip



39 neutro / serigrafia 42 x 30 mm  
39 neutral / screen printing 42 x 30 mm

(\*)  
**V1 – 30 CR**  
clip per incisione laser /  
clip for laser engraving  
**V1 – 30 CR T**  
clip per tampografia /  
clip for pad printing

## View

### V1 – AL CR / V1 – AL CR T \*

fusto e cappuccio verniciati in colore alluminio,  
clip in metallo cromato, punta cromata  
aluminium painted finish barrel and cap,  
metal chromed clip, chromed tip



**Valorizza il prestigio  
di un marchio con  
raffinata eleganza.**

*Refined elegance to enhance  
the prestige of a brand.*

alluminio / incisione laser 30 x 7 mm  
aluminium / laser engraving 30 x 7 mm

(\*)  
**V1 – AL CR**  
clip per incisione laser /  
clip for laser engraving  
**V1 – AL CR T**  
clip per tampografia /  
clip for pad printing



## View

# V1 – GOM C CR / V1 – GOM C CR T \*

fusto e cappuccio in colore coprente gommato,  
clip in metallo cromato, punta cromata  
solid colour barrel and cap with rubber finish,  
metal chrome clip, chromed tip



61 magenta / serigrafia 42 x 30 mm  
61 magenta / screen printing 42 x 30 mm

18 arancio / tampografia su clip 40 x 6 mm  
18 orange / pad printing on the clip 40 x 6 mm

64 azzurro pastello / incisione laser 30 x 7 mm  
64 pastel blue / laser engraving 30 x 7 mm

04 nero / tampografia su clip 40 x 6 mm  
04 black / pad printing on the clip 40 x 6 mm

(\*)  
**V1 – GOM C CR**  
clip per incisione laser /  
clip for laser engraving  
**V1 – GOM C CR T**  
clip per tampografia /  
clip for pad printing

tampografia  
pad printing

**Via libera ai colori,  
anche su metallo!**

*Free rein to colours  
on metals too!*

---

# Tag

eleganza imponente  
*imposing elegance*



**Design semplice  
e raffinato, omaggio  
all'eleganza perfetta.**

*Clean-cut, refined design,  
a tribute to perfect elegance.*

**Tag**  
informazioni  
tecniche  
*technical  
information*

**Tampografia  
e serigrafia  
disponibili  
anche su fusto  
gommato.**

*Pad and screen printing also  
available on rubberised barrel.*

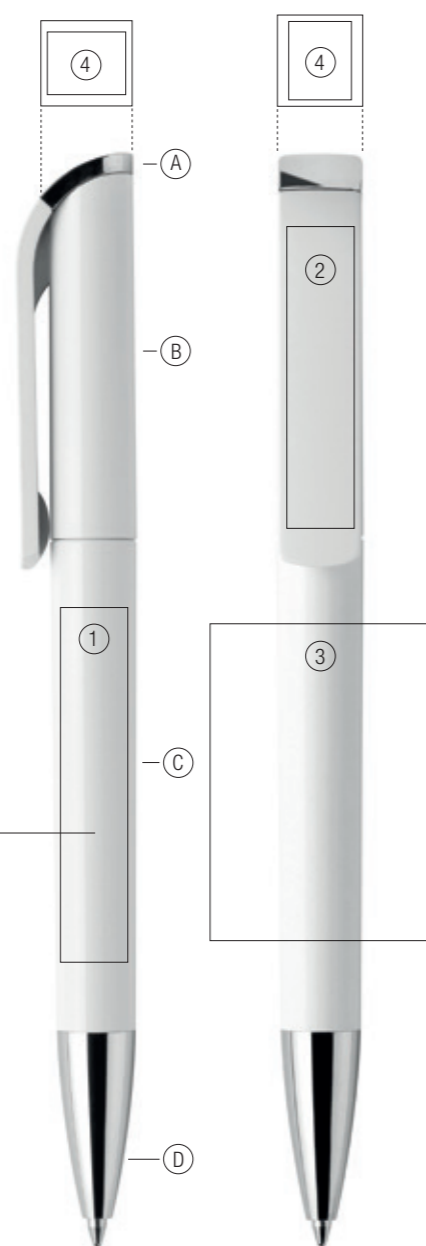

- |            |          |
|------------|----------|
| Ⓐ tassello | Ⓐ plug   |
| Ⓑ clip     | Ⓑ clip   |
| Ⓒ fusto    | Ⓒ barrel |
| Ⓓ punta    | Ⓓ tip    |

È possibile combinare particolari di colori diversi della stessa versione (o codice), oppure abbinare elementi di versioni differenti.

You can combine differently coloured parts from the same version (or code number), or elements from different versions.

1/5

**CARATTERISTICHE**

- meccanismo a rotazione
- realizzata in plastica ABS atossica e ad alta resistenza
- la cromatura della punta e del tassello superiore è ottenuta con trattamento galvanico
- refill Jumbo, inchiostro blu e nero
- disponibile con superfici lucide, satinare, gommate o verniciate con colori metallizzati o alluminio

**FEATURES**

- twist-action
- made of non-toxic, highly resistant ABS plastic
- galvanic process used to chrome tip and upper plug
- Jumbo refill, blue and black ink
- available in glossy, matt, rubberised and metallic or aluminium painted finish

2/5

**AREA STAMPABILE**

- ① tampografia 47 x 9 mm
- ② tampografia 40 x 9 mm
- ③ serigrafia 42 x 30 mm
- ④ tampografia 8 x 10 mm

**PRINT AREA**

- ① pad printing 47 x 9 mm
- ② pad printing 40 x 9 mm
- ③ screen printing 42 x 30 mm
- ④ pad printing 8 x 10 mm

3/5

**FUSTO**

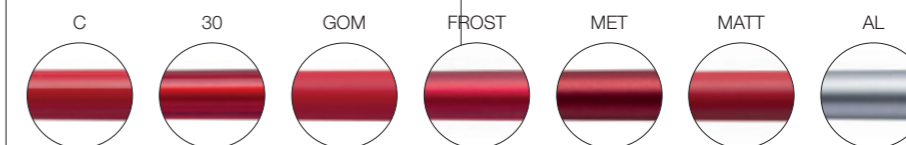

**BARREL**

4/5

**PUNTA E TASSELLO**

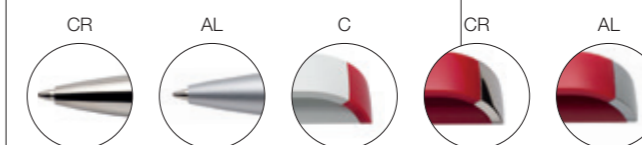

**TIP AND PLUG**

5/5

**COLORAZIONI**

- coprenti
  - 01 70 03 18 15 74 60 61 71 25 72 73 79 09 75 27 64 12 22 04
- trasparenti
  - 39 52 53 45 51 55 49 47 44 40
- vernici metallizzate
  - 92 83 85 94 95 96
- trattamento galvanico

**COLOURS**

- solid
- transparent
- metallic paintings
- galvanic process

## Tag

# TA1 – MATT AL B

fusto e clip in colore bianco coprente con finitura satinata,  
tassello superiore in colori coprenti con finitura lucida,  
punta verniciata in colore alluminio.  
solid white colour barrel and clip with matt finish, solid colour  
upper plug with glossy finish, aluminium painted finish tip



01 bianco / tampografia 40 x 9 mm  
01 white / pad printing 40 x 9 mm  
—  
serigrafia 42 x 30 mm  
screen printing 42 x 30 mm



61 magenta / tampografia 40 x 9 mm  
61 magenta / pad printing 40 x 9 mm



64 azzurro pastello / tampografia 40 x 9 mm  
64 pastel blue / pad printing 40 x 9 mm



# Tag TA1 – B CR

cfusto e clip in colore bianco, tassello superiore in colori coprenti, finiture lucide, punta cromata  
solid white colour barrel and clip, solid colour upper plug, glossy finishes, chromed tip



15 rosso / tampografia 40 x 9 mm  
15 red / pad printing 40 x 9 mm

04 nero / tampografia 40 x 9 mm  
04 black / pad printing 40 x 9 mm

# Tag TA1 – CB CR

colori coprenti con finitura lucida, punta cromata  
solid colours with glossy finish, chromed tip



18 arancio / tampografia 40 x 9 mm  
18 orange / pad printing 40 x 9 mm

61 magenta / tampografia 40 x 9 mm  
61 magenta / pad printing 40 x 9 mm

## Tag

# TA1 – MATT AL

colori coprenti con finitura satinata, tassello superiore e punta verniciati in colore alluminio  
solid colours with matt finish, aluminium painted finish upper plug and tip



01 bianco / tampografia 40 x 9 mm  
01 white / pad printing 40 x 9 mm



03



18 arancio / tampografia 40 x 9 mm  
18 orange / pad printing 40 x 9 mm

15

61

25

79

09

22

04

## Tag

# TA1 – FROST AL

colori trasparenti con finitura satinata, tassello superiore e punta verniciati in colore alluminio  
transparent colours with matt finish, aluminium painted finish upper plug and tip



52 giallo / tampografia 40 x 9 mm  
52 yellow / pad printing 40 x 9 mm



39



53



45 rosso / tampografia 40 x 9 mm  
45 red / pad printing 40 x 9 mm



51

55

49

47

44

40

**Lo stile rigoroso è ingentilito dalla dolce curvatura della clip e del suo tassello di chiusura.**

*Its rigorous styling is softened by the smooth curve of the clip and closing plug.*

## Tag

# TA1 – C CR

colori coprenti con finitura lucida,  
tassello superiore e punta cromati  
solid colours with glossy finish,  
chromed upper plug and tip

## Eleganza e linearità per esprimere tutta la forza di un brand.

*Elegance and linearity to express  
all the strength of a brand.*

01 bianco / tampografia 40 x 9 mm  
01 white / pad printing 40 x 9 mm



70 03 18 15 74 60 61 71 25 72

64 azzurro pastello / tampografia 40 x 9 mm  
64 pastel blue / pad printing 40 x 9 mm



79 09 75 27

73 marrone / tampografia 40 x 9 mm  
73 brown / pad printing 40 x 9 mm



12 22 04

## Tag

# TA1 – 30 CR

colori trasparenti con finitura lucida,  
tassello superiore e punta cromati  
transparent colours with glossy finish,  
chromed upper plug and tip

44 blu / tampografia 40 x 9 mm  
44 blue / pad printing 40 x 9 mm

tampografia 47 x 9 mm  
pad printing 47 x 9 mm



## Tag

# TA1 – GOM C CR

fusto in colore coprente gommato, clip in colore coprente  
con finitura lucida, tassello superiore e punta cromati  
solid colour barrel with rubber finish, solid colour clip  
with glossy finish, chromed upper plug and tip

**Fusto gommato: piace perché è bello da vedere e da toccare.**

*Rubber finish barrel: popular because it is good to look at and pleasant to touch.*

04 nero / tampografia 40 x 9 mm  
04 black / pad printing 40 x 9 mm



72 cuoio / tampografia 40 x 9 mm  
72 leather / pad printing 40 x 9 mm





## Tag

# TA1 – MET AL

fusto e clip verniciati in colori metallizzati, tassello superiore e punta verniciati in colore alluminio  
metallic colours painted finish barrel and clip, aluminium painted finish upper plug and tip



85 rosso / tampografia 40 x 9 mm  
85 red / pad printing 40 x 9 mm



92

83



94

95

96



### MY BOX

Astuccio universale richiudibile per penna singola in cartoncino nero Fedrigoni.  
Info pag. 229

Universal reclosable single pen box in Fedrigoni black card.  
Info at p. 229

## Tag

# TA1 – AL CR

fusto e clip verniciati in colore alluminio, tassello superiore e punta cromati  
aluminium painted finish barrel and clip, chromed upper plug and tip



alluminio / tampografia 40 x 9 mm  
aluminum / pad printing 40 x 9 mm

---

# Icon

design senza tempo  
*timeless design*



**L'incontro tra passato,  
presente e futuro.**

*A perfect synthesis of past,  
present and future.*

# Icon

## informazioni tecniche

*technical information*

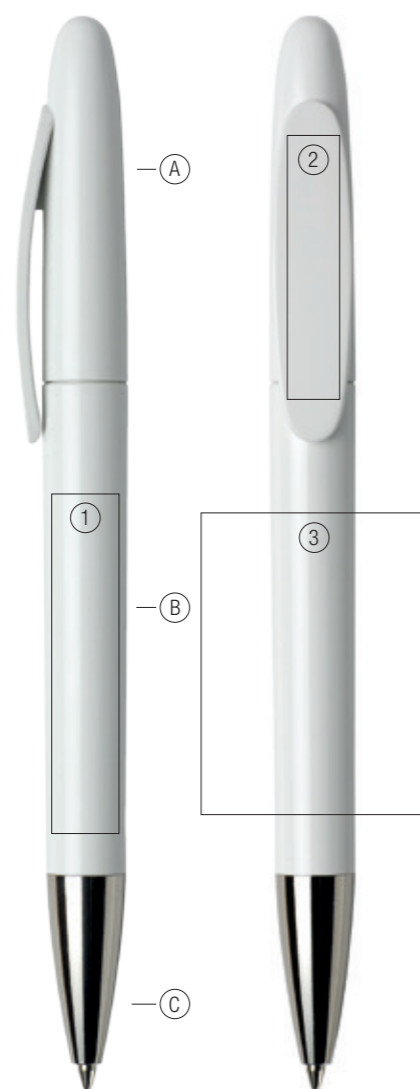

È possibile combinare particolari di colori diversi della stessa versione (o codice), oppure abbinare elementi di versioni differenti.

You can combine differently coloured parts from the same version (or code number), or elements from different versions.

- A** cappuccio      **A** cap
- B** fusto            **B** barrel
- C** punta             **C** tip

1/4

### CARATTERISTICHE

- meccanismo a rotazione
- realizzata in plastica ABS, atossica e ad alta resistenza
- la cromatura e la doratura della punta in ABS sono ottenute con trattamento galvanico
- refill Jumbo, inchiostro blu e nero
- disponibile con superfici lucide, satinare o verniciate in colori metallizzati o alluminio

### FEATURES

- twist-action
- made of non-toxic, highly resistant ABS plastic
- galvanic process used to chrome and gild ABS tip
- Jumbo refill, blue and black ink
- available in glossy, matt and metallic or aluminium painted finish

2/4

### AREA STAMPABILE

- 1 tampografia 45 x 9 mm
- 2 tampografia 35 x 7 mm
- 3 serigrafia 40 x 30 mm

### PRINT AREA

- 1 pad printing 45 x 9 mm
- 2 pad printing 35 x 7 mm
- 3 screen printing 40 x 30 mm

3/5

### FUSTO

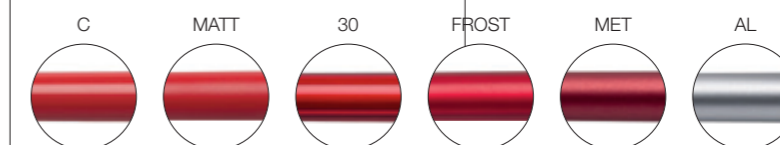

### BARREL

4/5

### PUNTA



### TIP

5/5

### COLORAZIONI

- coprenti
- 01 70 03 18 15 74 60 61 71
- trasparenti
- 39 52 53 45 51 55 49 47 44 40
- vernici metallizzate
- 92 83 85 94 95 96
- trattamento galvanico

### COLOURS

- solid
- 25 72 73 79 09 75 27 64 12 22 04
- transparent
- 40
- metallic paintings
- galvanic process

## Icon

### IC400 – C

colori coprenti con finitura lucida  
solid colours with glossy finish

**Design dal profilo  
essenziale e armonico per  
uno stile mai scontato  
e sempre attuale.**

*Essential, harmonious design for a style that  
is never banal and always up-to-date.*

18 arancio / tampografia 35 x 7 mm  
18 orange / pad printing 35 x 7 mm



25 viola scuro / tampografia 35 x 7 mm  
25 dark violet / pad printing 35 x 7 mm

## Icon

### IC400 – MATT

colori coprenti con finitura satinata  
solid colours with matt finish

79 lime / tampografia 35 x 7 mm  
79 lime / pad printing 35 x 7 mm



## Icon

# IC400 – 30

colori trasparenti con finitura lucida  
transparent colours with glossy finish

49 verde / tampografia 35 x 7 mm  
49 green / pad printing 35 x 7 mm



39 52 53 45 51 55



47 44 40

## Icon

# IC400 – FROST

colori trasparenti con finitura satinata  
transparent colours with matt finish

44 blu / tampografia 35 x 7 mm  
44 blue / pad printing 35 x 7 mm



39 52 53 45



55 49 47



40

51 viola / serigrafia 40 x 30 mm  
51 violet / screen printing 40 x 30 mm

## Icon

# IC400 – MATT AL

colori coprenti con finitura satinata,  
punta verniciata in colore alluminio  
solid colours with matt finish,  
aluminium painted tip

71 viola chiaro / tampografia 35 x 7 mm  
71 light violet / pad printing 35 x 7 mm

18 arancio / tampografia 35 x 7 mm  
18 orange / pad printing 35 x 7 mm



**Il fusto e la clip sono progettati per offrire ampi spazi di personalizzazione e rispondere alle esigenze di ogni cliente.**

*The barrel and clip have been designed to provide ample space for personalisation to meet each customer's requirements.*

04 nero / serigrafia 40 x 30 mm  
04 black / screen printing 40 x 30 mm



27 ottanio / tampografia 35 x 7 mm  
27 octan green / pad printing 35 x 7 mm



**Icon**

IC400 – C CR

colori coprenti con finitura lucida, punta cromata  
solid colours with glossy finish, chromed tip



61 magenta / tampografia 35 x 7 mm  
61 magenta / pad printing 35 x 7 mm



70 03 18 15 74 60

01 bianco / tampografia 45 x 9 mm  
01 white / pad printing 45 x 9 mm



71 25



72



73 marrone / tampografia 35 x 7 mm  
73 brown / pad printing 35 x 7 mm



79 09



75 verde scuro / tampografia 35 x 7 mm  
75 dark green / pad printing 35 x 7 mm



27 64 12 22 04

## Icon

# IC400 – FROST AL

colori trasparenti con finitura satinata,  
punta verniciata in colore alluminio  
transparent colours, matt finish,  
aluminium painted finish tip

40 grigio / tampografia 35 x 7 mm  
40 grey / pad printing 35 x 7 mm

53 arancio / tampografia 35 x 7 mm  
53 orange / pad printing 35 x 7 mm

serigrafia 40 x 30 mm  
screen printing 40 x 30 mm



39



52



45



51



55



49



47



44



## Icon

# IC400 – 30 CR

colori trasparenti con finitura  
lucida, punta cromata  
transparent colours with  
glossy finish, chromed tip

45 rosso / tampografia 35 x 7 mm  
45 red / pad printing 35 x 7 mm

47 acquamarina / tampografia 35 x 7 mm  
47 aquamarine / pad printing 35 x 7 mm



39



52



53



51



55



49



44



40



## Icon

# IC400 – C GOLD

colori coprenti con finitura lucida, punta dorata  
solid colours with glossy finish, gilded tip



### MY CASE

Astuccio universale  
per penna singola  
in cartoncino nero  
Fedrigoni.  
Info pag. 228

Universal single  
pen box in Fedrigoni  
black card.  
Info at p. 228



04 nero / serigrafia 40 x 30 mm  
04 black / screen printing 40 x 30 mm



## Icon

# IC400 – MET AL

fusto e cappuccio verniciati in colori metallizzati,  
punta verniciata in colore alluminio  
metallic colours painted finish barrel and cap,  
aluminium painted finish tip

## Esclusivi colori metallizzati ad alta resistenza.

Exclusive *high strength* metallic colours.



alluminio / tampografia 35 x 7 mm  
aluminium / pad printing 35 x 7 mm

83 rame / tampografia 35 x 7 mm  
83 copper / pad printing 35 x 7 mm



# IC400 – AL CR

fusto e cappuccio verniciati  
in colore alluminio,  
punta cromata  
aluminium painted finish  
barrel and cap, chromed tip



---

# Tag green

obiettivo: sicurezza totale  
*objective: total safety*



**Il design sposa  
la sicurezza e rispetta  
l'ambiente.**

*Design that combines safety  
and environment friendliness.*

# “Realizzata con plastica idonea alla produzione dei giocattoli.”

“Made from a special plastic, suitable for use in toy manufacture.”



## Guarda al futuro

Prodotta con plastica idonea all'utilizzo nei giocattoli (direttiva europea EN 71 - 03 e direttiva americana FDA).

**Looking to the future**  
Made of plastic suitable for toy manufacture (according to European standard EN 71-03 and U.S. FDA regulations).



## Antibacterial

La plastica è antibatterica, grazie ad uno speciale additivo che sprigiona ioni d'argento impedendo ai batteri di depositarsi sulle superfici della penna.

**Antibacterial**  
It is made of antibacterial plastic containing a special additive which releases silver ions that prevent bacteria from colonising the surface of the pen.

LOVING NATURE

Antibatterica, atossica e sostenibile. Una penna che dura ama la natura.

Antibacterial, non-toxic and sustainable. A pen that lasts is a pen that loves nature.



## Vicina all'ambiente

Realizzata con materiali atossici, è stata progettata per durare a lungo nel tempo. Una penna che dura di più inquina di meno perchè rimane a lungo nelle nostre mani, massimizzando la diffusione del logo o del messaggio che porta con sé.

**Nature friendly**  
Made of non-toxic plastics, it has been designed to have a long life and to minimise the risk of harmful substances being released into the environment. Using a pen for as long as possible helps to reduce pollution and enables us to give full expression to the concept of promotion.



## Green Chemical

**Non contiene:** diossina, ftalati, bisfenolo A, antimonio, arsenico, bario, cadmio, cromo, mercurio, piombo, ed è conforme alle normative RoHS e REACH. Bifenili polibromurati (PBB), eteri di difenile (PBDE) e deca BDE sono completamente assenti, ed è conforme alle normative RoHS e REACH.

**Green Chemical**  
It does not contain dioxin, phthalates, bisphenol A, antimony, arsenic, barium, cadmium, chrome, mercury, lead, polybrominated biphenyls (PBBs), polybrominated diphenyl ethers (PBDEs) or deca-BDE, and conforms to RoHS and REACH directives.



## Buona davvero

Le plastiche utilizzate sono conformi alla normativa europea e americana FDA per il contatto alimentare.

**Really safe**  
The plastics employed are compliant with European and American FDA food contact regulations.



## Conforme alle regole

La plastica non risulta pericolosa per il CLP (classification, labeling and packaging).

**CLP compliant**  
It is rated as non hazardous pursuant to the Regulation on Classification, Labelling and Packaging.

# Tag green

## informazioni tecniche

technical information



È possibile combinare particolari di colori diversi della stessa versione (o codice), oppure abbinare elementi di versioni differenti.

You can combine differently coloured parts from the same version (or code number), or elements from different versions.

- A** tassello
- B** clip
- C** fusto
- A** plug
- B** clip
- C** barrel

### 1/5

#### CARATTERISTICHE

- meccanismo a rotazione
- realizzata in plastica ABS speciale, ad alta resistenza, atossica e certificata per l'utilizzo nei giocattoli
- antibatterica
- refill X-20, inchiostro blu e nero
- disponibile con superfici lucide

#### FEATURES

- twist-action
- made of non-toxic, highly resistant special ABS plastic certified for use in toy manufacture
- antibacterial
- X20 refill, blue and black ink
- available in glossy finish

### 2/5

#### AREA STAMPABILE

- ① tampografia 45 x 9 mm
- ② tampografia 40 x 9 mm
- ③ serigrafia 40 x 30 mm
- ④ tampografia 8 x 10 mm

#### PRINT AREA

- ① pad printing 45 x 9 mm
- ② pad printing 40 x 9 mm
- ③ screen printing 40 x 30 mm
- ④ pad printing 8 x 10 mm

### 3/5

#### FUSTO

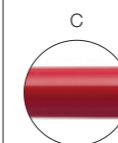

### 4/5

#### TASSELLO

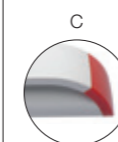

### 5/5

#### COLORAZIONI

- colori coprenti speciali



#### BARREL

#### PLUG

#### COLOURS

- special solid colours

#### MY CASE

Per questo modello è disponibile l'astuccio My Case Green in cartoncino FSC in due versioni:

- con testi descrittivi in italiano
- con testi descrittivi in inglese

The My Case Green is available in FSC card for this model in two versions:

- with descriptive texts in Italian
- with descriptive texts in English



## Tag green TA2 – B

fusto e clip in colore bianco coprente, tassello superiore in colori coprenti, finiture lucide  
solid white colour barrel and clip,  
solid colours upper plug, glossy finishes

**La plastica Green Chemical sprigiona ioni d'argento che svolgono una **funzione antibatterica.****

*Green Chemical plastic releases silver ions that have an **anti-bacterial function.***

01 bianco / tampografia 40 x 9 mm  
01 white / pad printing 40 x 9 mm



## Tag green TA2 – BC

fusto e tassello superiore in colore bianco coprente, clip in colori coprenti, finiture lucide  
solid white colour barrel and upper plug,  
solid colours clip, glossy finishes

54 blu / tampografia 40 x 9 mm  
54 blue / pad printing 40 x 9 mm

29 verde / tampografia 40 x 9 mm  
29 green / pad printing 40 x 9 mm



---

# Icon green

nel rispetto dell'uomo e della natura  
*people and environment friendly*



**Testimone di un  
messaggio destinato  
a durare nel tempo.**

*Testimony of an enduring message.*

# “Un significativo passo avanti nella sicurezza della plastica.”

“A significant step forward toward the use of safe plastic.”



## Vicina all'ambiente

**Realizzata con materiali atossici**, è stata progettata per durare a lungo nel tempo. **Una penna che dura di più inquina di meno** perchè rimane a lungo nelle nostre mani, massimizzando la diffusione del logo o del messaggio che porta con sé.

### Nature friendly

Made of non-toxic plastics, it has been designed to have a long life and to minimise the risk of harmful substances being released into the environment. **Using a pen for as long as possible helps to reduce pollution** and enables us to give full expression to the concept of promotion.



## Green Chemical

**Non contiene:** diossina, ftalati, bisfenolo A, antimonio, arsenico, bario, cadmio, cromo, mercurio, piombo, ed è **conforme alle normative RoHS e REACH**. Bifenili polibromurati (PBB), eteri di difenile (PBDE) e deca BDE **sono completamente assenti, ed è conforme alle normative RoHS e REACH**.

### Green Chemical

**It does not contain** dioxin, phthalates, bisphenol A, antimony, arsenic, barium, cadmium, chrome, mercury, lead, polybrominated biphenyls (PBBs), polybrominated diphenyl ethers (PBDEs) or deca-BDE, and **conforms to RoHS and REACH directives**.

## LOVING NATURE

Antibatterica, atossica e sostenibile. Una penna che dura ama la natura.

Antibacterial, non-toxic and sustainable. A pen that lasts is a pen that loves nature.



## Guarda al futuro

**Prodotta con plastica idonea all'utilizzo nei giocattoli** (direttiva europea EN 71 - 03 e direttiva americana FDA).

### Looking to the future

Made of plastic suitable for **toy manufacture** (according to European standard EN 71-03 and U.S. FDA regulations).



## Antibacterial

**La plastica è antibatterica**, grazie ad uno speciale additivo che sprigiona ioni d'argento impedendo ai batteri di depositarsi sulle superfici della penna.

### Antibacterial

It is made of **antibacterial plastic** containing a special additive which releases silver ions that prevent bacteria from colonising the surface of the pen.



## Buona davvero

Le plastiche utilizzate sono **conformi alla normativa europea e americana FDA per il contatto alimentare**.

### Really safe

The plastics employed **are compliant with European and American FDA food contact regulations**.



## Conforme alle regole

**La plastica non risulta pericolosa per il CLP** (classification, labeling and packaging).

### CLP compliant

It is rated as **non hazardous** pursuant to the Regulation on Classification, Labelling and Packaging.

# Icon green

## informazioni tecniche

### technical information



È possibile combinare particolari di colori diversi della stessa versione (o codice), oppure abbinare elementi di versioni differenti.

You can combine differently coloured parts from the same version (or code number), or elements from different versions.

A cappuccio

B fusto

A cap

B barrel

1/5

#### CARATTERISTICHE

- meccanismo a rotazione
- realizzata in plastica ABS speciale, ad alta resistenza, atossica e certificata per l'utilizzo nei giocattoli
- antibatterica
- refill X20, inchiostro blu e nero
- disponibile con superfici lucide

2/5

#### AREA STAMPABILE

- 1 tampografia 45 x 9 mm
- 2 tampografia 35 x 7 mm
- 3 serigrafia 40 x 30 mm

3/5

#### FUSTO

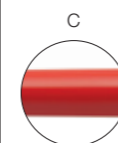

4/5

#### CAPPUCCIO

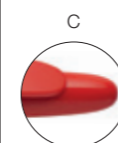

5/5

#### COLORAZIONI

- colori coprenti speciali



#### FEATURES

- twist-action
- made of non-toxic, highly resistant special ABS plastic certified for use in toy manufacture
- antibacterial
- X20 refill, blue and black ink
- available in glossy finish

#### PRINT AREA

- 1 pad printing 45 x 9 mm
- 2 pad printing 35 x 7 mm
- 3 screen printing 40 x 30 mm

#### BARREL

#### CAP

#### COLOURS

- special solid colours

#### MY CASE

Per questo modello è disponibile l'astuccio My Case Green in cartoncino FSC in due versioni:

- con testi descrittivi in italiano
- con testi descrittivi in inglese

The My Case Green is available in FSC card for this model in two versions:

- with descriptive texts in Italian
- with descriptive texts in English





## Icon green IG2 – BC

fusto in colore bianco coprente,  
cappuccio in colori coprenti, finiture lucide  
solid white colour barrel, solid colours cap,  
glossy finishes

35 rosso / tampografia 35 x 7 mm  
35 red / pad printing 35 x 7 mm



42

43

Realizzata con una  
plastica speciale idonea  
alla produzione  
di giocattoli.

*Made of special plastic used  
to manufacture children's toys.*

29 verde / tampografia 35 x 7 mm  
29 green / pad printing 35 x 7 mm



13

65

54

04

## Icon green IG2 – C

colori solidi con finitura lucida  
solid colours with glossy finish

65 verde scuro / tampografia 35 x 7 mm  
65 dark green / pad printing 35 x 7 mm

01 bianco / tampografia 35 x 7 mm  
01 white / pad printing 35 x 7 mm



70

42

43

35

13

29

54

04

---

# Ethic

eleganza e flessibilità  
*elegance and flexibility*



**Costruita a misura  
di cliente.**

*Tailored to the customer's requirements.*

# Ethic

## informazioni tecniche

*technical information*



È possibile combinare particolari di colori diversi della stessa versione (o codice), oppure abbinare elementi di versioni differenti.

You can combine differently coloured parts from the same version (or code number), or elements from different versions.

- |               |               |
|---------------|---------------|
| ● A tappino   | ● A small cap |
| ● B cappuccio | ● B cap       |
| ● C anelli    | ● C rings     |
| ● D fusto     | ● D barrel    |
| ● E punta     | ● E tip       |

1/4

### CARATTERISTICHE

- meccanismo a rotazione
- realizzata in plastica ABS, atossica e ad alta resistenza
- clip in metallo, con finitura cromata, dorata o verniciata color alluminio
- la cromatura e la doratura delle parti in ABS sono ottenute con trattamento galvanico
- refill Jumbo, inchiostro blu e nero
- disponibile con superfici lucide o verniciate in colori metallizzati o alluminio

### FEATURES

- twist-action
- made of non-toxic, highly resistant ABS plastic
- metal clip with chrome, gilded or aluminium painted finish
- galvanic process used to chrome or to gild ABS parts
- Jumbo refill, blue and black ink
- available in glossy and metallic or aluminium painted finish

2/4

### AREA STAMPABILE

- 1 tampografia 30 x 8 mm
- 2 serigrafia 45 x 30 mm
- 3 tampografia 55 x 9,5 mm

### PRINT AREA

- 1 pad printing 30 x 8 mm
- 2 screen printing 45 x 30 mm
- 3 pad printing 55 x 9,5 mm

3/4

### FUSTO

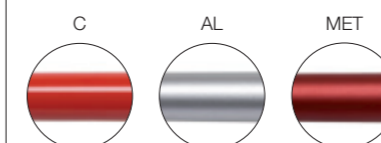

### BARREL

### PUNTA E ANELLI

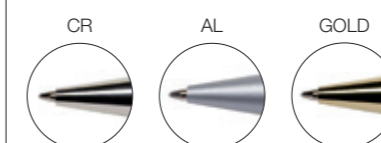

### TIP AND RINGS

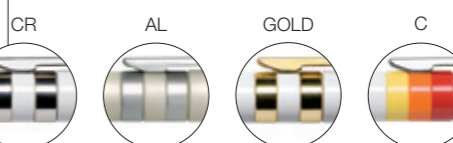

4/4

### COLORAZIONI

- coprenti
- 01 70 03 18 15 74 25 09 75
- vernici metallizzate
- 91 92 83 85 81 82 89 94 95 96
- trattamento galvanico

### COLOURS

- solid
- 27 12 22 04
- metallic paintings
- galvanic process

## Ethic

# ET900 – MULTICOLOUR

colori coprenti con finitura lucida,  
clip in metallo cromato, punta cromata  
solid colours with glossy finish, metal  
chrome finish clip, chromed tip

**Pensata per durare  
oltre le mode del  
momento, come il  
messaggio che deve  
trasmettere.**

*Designed to outlast passing fashions,  
like the message it conveys.*



G verde / tampografia 55 x 9,5 mm  
G green / pad printing 55 x 9,5 mm

## Ethic

# ET900 – FLAG

colori coprenti con finitura lucida,  
clip in metallo cromato, punta cromata  
solid colours with glossy finish, metal  
chrome finish clip, chromed tip



IT / tampografia 55 x 9,5 mm  
IT / pad printing 55 x 9,5 mm

# ET900 – C FLAG

colori coprenti con finitura lucida,  
clip in metallo cromato, punta cromata  
solid colours with glossy finish, metal  
chrome finish clip, chromed tip



04 IT / tampografia 55 x 9,5 mm  
04 IT / pad printing 55 x 9,5 mm

## Ethic

### ET900 – B

colori coprenti con finitura lucida,  
clip in metallo cromato, punta cromata  
solid colours with glossy finish, metal  
chrome finish clip, chromed tip

**Punta, fusto, cappuccio, tappino  
e 3 anelli disponibili in una ricca  
gamma di colori: più di 300  
milioni di combinazioni possibili!**

*Tip, barrel, cap, push-button and 3 rings  
available in a vast range of colours: more  
than 300 million combinations possible!*



18 arancio / tampografia 55 x 9,5 mm  
18 orange / pad printing 55 x 9,5 mm

04 nero / tampografia 55 x 9,5 mm  
04 black / pad printing 55 x 9,5 mm

## Ethic

### ET900 – BC

colori coprenti con finitura lucida,  
clip in metallo cromato, due anelli  
e punta cromati, tappino bianco  
solid colours with glossy finish,  
metal chrome finish clip, white  
top, chromed tip and two rings



15 rosso / tampografia 30 x 8 mm  
15 red / pad printing 30 x 8 mm

serigrafia 45 x 30 mm  
screen printing 45 x 30 mm

## Ethic

# ET900 – C CR

colori coprenti con finitura lucida, clip in metallo cromato, due anelli, punta e tappino cromati  
solid colours with glossy finish, metal chrome finish clip, chromed tip, top and two rings



03 giallo / tampografia 55 x 9,5 mm  
03 yellow / pad printing 55 x 9,5 mm

74 bordeaux / tampografia 55 x 9,5 mm  
74 burgundy / pad printing 55 x 9,5 mm

# ET900 – C GOLD

colori coprenti con finitura lucida, clip in metallo dorato, due anelli, punta e tappino dorati  
solid colours with glossy finish, gilded metal finish clip, gilded tip, top and two rings

## I dettagli, cromati o dorati, ne esaltano l'eleganza.

*The chrome or gilded details enhance the pen's elegance.*



01 bianco / serigrafia 45 x 30 mm  
01 white / screen printing 45 x 30 mm

## Ethic

### ET900 – AL

fusto, cappuccio e anello centrale verniciati in colore alluminio, due anelli e tappino in colore coprente con finitura lucida, clip in metallo cromato, punta cromata  
aluminium painted finish barrel, cap and central ring, solid colour two rings and top with glossy finish, metal chrome finish clip, chromed tip



## Ethic

### ET900 – AL CR

fusto, cappuccio e anello centrale verniciati in colore alluminio, clip in metallo cromato, due anelli, tappino e punta cromati  
aluminium painted finish barrel, cap and central ring, metal chrome finish clip, chromed tip, top, and two rings

chrome



**Design raffinato e flessibile, per i brand più esigenti.**

*Refined, flexible design for the most demanding brands.*

09



IT

## Ethic ET900 – MET CR

fusto, cappuccio e anello centrale verniciati in colori metallizzati, clip in metallo cromato, due anelli, tappino e punta cromati  
 metallic colours painted finish barrel, cap and central ring, metal chrome finish clip, chromed tip, top and two rings



## Ethic ET900 – MET AL

fusto, cappuccio e anello centrale verniciati in colori metallizzati, clip in metallo verniciato in colore alluminio, due anelli, tappino e punta verniciati in colore alluminio  
 metallic colours painted finish barrel, cap and central ring, metal aluminium painted finish clip, aluminium painted finish tip, top and two rings





---

# Next

la forma che verrà  
*the shape for the future*



**Scattante e dinamica:  
l'accelerazione positiva  
per ogni brand.**

*Sleek, dynamic lines, able to boost  
the visibility and identity of every brand.*

**Next**  
informazioni  
tecniche  
*technical  
information*

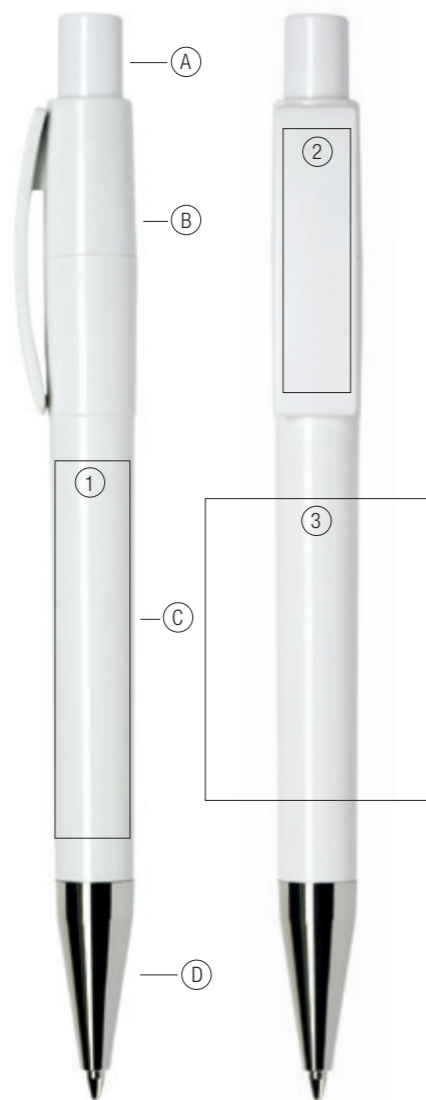

- |           |               |
|-----------|---------------|
| Ⓐ tappino | Ⓐ push-button |
| Ⓑ clip    | Ⓑ clip        |
| Ⓒ fusto   | Ⓒ barrel      |
| Ⓓ punta   | Ⓓ tip         |

È possibile combinare particolari di colori diversi della stessa versione (o codice), oppure abbinare elementi di versioni differenti.

You can combine differently coloured parts from the same version (or code number), or elements from different versions.

1/5

**CARATTERISTICHE**

- meccanismo a scatto, con molla di ritorno
- tappino ventilato
- realizzata in plastica ABS, atossica e ad alta resistenza
- refill Jumbo, inchiostro blu e nero
- il fusto è disponibile con superfici lucide, satinare, gommate o verniciate con colori metallizzati o alluminio
- la cromatura della punta in ABS è ottenuta con trattamento galvanico
- le versioni con fusto gommato sono stampabili solo su clip

**FEATURES**

- retractable with return spring
- ventilated push-button
- made of non-toxic, highly resistant ABS plastic
- Jumbo refill, blue and black ink
- the barrel is available in glossy, matt, rubberised and metallic or aluminium painted finish
- galvanic process used to chrome the ABS tip
- rubberised barrel versions are only printable on the clip

2/5

**AREA STAMPABILE**

- ① tampografia 50 x 10 mm
- ② tampografia 35 x 9 mm
- ③ serigrafia 40 x 30 mm

**PRINT AREA**

- ① pad printing 50 x 10 mm
- ② pad printing 35 x 9 mm
- ③ screen printing 40 x 30 mm

3/5

**FUSTO**



**BARREL**

4/5

**PUNTA E TAPPINO**

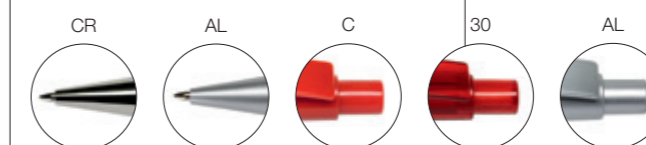

**TIP AND PUSH-BUTTON**

5/5

**COLORAZIONI**

- coprenti
- ① 01 70 03 18 15 74 09 12 22 04
- trasparenti
- ② 39 52 53 45 51 55 49 47 44 40
- vernici metallizzate
- 92 83 85 94 95 96
- trattamento galvanico

**COLOURS**

- solid
- transparent
- metallic paintings
- galvanic process

**Next**

# NX400 – C CR

colori coprenti con finitura lucida, punta cromata  
solid colours with glossy finish, chromed tip



70 03 18 15 74 09 12 22

04 nero / tampografia 50 x 10 mm  
04 black / pad printing 50 x 10 mm



01 bianco / tampografia 50 x 10 mm  
01 white / pad printing 50 x 10 mm

**Next**

# NX400 – 30 CR

colori trasparenti con finitura lucida, punta cromata  
transparent colours with glossy finish, chromed tip



39 52 53 45 55 49 44 40

47 acquamarina / tampografia 35 x 9 mm  
47 aquamarine / pad printing 35 x 9 mm



51 viola / tampografia 35 x 9 mm  
51 violet / pad printing 35 x 9 mm



## Next

# NX400 – FROST AL

fusto in colore trasparente con finitura satinata, clip,  
tappino e punta verniciati in colore alluminio  
transparent colour barrel with matt finish,  
aluminium painted finish clip, push-button and tip

**La clip: uno schermo  
su cui trasmettere  
l'immagine di un brand.**

*The clip: a screen  
for conveying brand image.*

44 blu / tampografia 35 x 9 mm  
44 blue / pad printing 35 x 9 mm

49 verde / tampografia 35 x 9 mm  
49 green / pad printing 35 x 9 mm



## Next

# NX400 – MET AL

fusto verniciato in colori metallizzati, clip,  
tappino e punta verniciati in colore alluminio  
metallic colours painted finish barrel, aluminium  
painted finish clip, push-button and tip

alluminio / tampografia 35 x 9 mm  
aluminium / pad printing 35 x 9 mm

85 rosso / tampografia 50 x 10 mm  
85 red / pad printing 50 x 10 mm



## Next

# NX400 – GOM C CR

fusto in colore coprente gommato, clip e tappino  
in colori coprenti con finitura lucida, punta cromata  
solid colour barrel with rubber finish, solid colour  
clip and push-button with glossy finish, chromed tip



74 bordeaux / tampografia 35 x 9 mm  
74 burgundy / pad printing 35 x 9 mm

03

18

15

09



12 azzurro / tampografia 35 x 9 mm  
12 light blue / pad printing 35 x 9 mm



22



04

## Next

# NX400 – GOM AL

fusto in colore coprente gommato, clip,  
tappino e punta verniciati in colore alluminio  
solid colour barrel with rubber finish, aluminium  
painted finish clip, push-button and tip



03 giallo / tampografia 35 x 9 mm  
03 yellow / pad printing 35 x 9 mm



18



15



74



09 verde / tampografia 35 x 9 mm  
09 green / pad printing 35 x 9 mm



12



22



04

**Il tappino è ventilato  
per garantire  
sufficiente passaggio  
di aria in caso  
di ingestione.**

*The ventilated push-button  
ensures sufficient airflow  
if inadvertently swallowed.*

---

# Pixel

il design ad alta definizione  
*high resolution design*



**Sintesi dello stile  
contemporaneo.**

*A synthesis of contemporary style.*

**Pixel**  
informazioni  
tecniche  
*technical  
information*

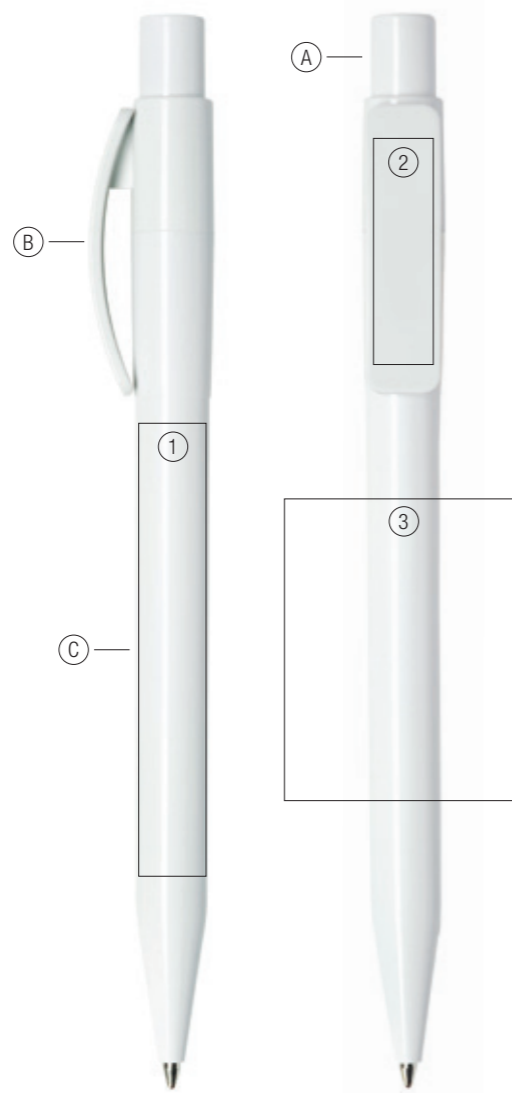

Vai su **maxema.com**  
per scegliere i tuoi  
colori preferiti.

Go to **maxema.com** to choose  
your favourite colours.

- Ⓐ tappino
- Ⓑ clip
- Ⓒ fusto
- Ⓐ push-button
- Ⓑ clip
- Ⓒ barrel

1/5

**CARATTERISTICHE**

- meccanismo a scatto
- tappino ventilato
- realizzata in plastica ABS, atossica e ad alta resistenza
- refill X 20, inchiostro blu e nero
- il fusto è disponibile con superfici lucide, satinare o gommate
- la cromatura del tappino in ABS è ottenuta con trattamento galvanico
- le versioni PX 40 - GOM C CR e PX 40 - GOM 30 CR sono stampabili solo sulla clip

**FEATURES**

- retractable
- ventilated push-button
- made of non-toxic, highly resistant ABS plastic
- X-20 refill, blue and black ink
- the barrel is available in glossy, matt or rubberised finish
- galvanic process used to chrome the ABS push-button
- the PX 40 - GOM C CR and PX 40 - GOM 30 CR versions are only printable on the clip

2/5

**AREA STAMPABILE**

- ① tampografia 60 x 9 mm
- ② tampografia 30 x 8 mm
- ③ serigrafia 40 x 31 mm

**PRINT AREA**

- ① pad printing 60 x 9 mm
- ② pad printing 30 x 8 mm
- ③ screen printing 40 x 31 mm

3/5

**FUSTO**

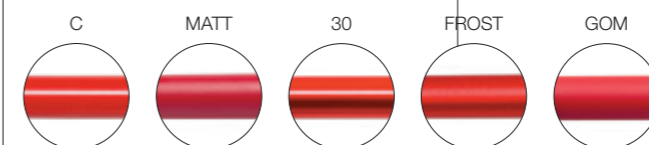

**BARREL**

4/5

**TAPPINO**

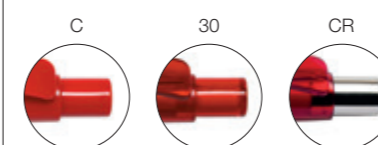

**PUSH-BUTTON**

5/5

**COLORAZIONI**

- coprenti
- ① 01 70 03 18 15 74 60 61 71
- trasparenti
- ① 39 52 53 45 59 41 51 31 55
- trattamento galvanico

**COLOURS**

- solid
- ① 25 73 79 09 75 26 27 64 77 12 22 05 04
- transparent
- ① 37 38 78 49 47 34 67 44 40 50
- galvanic process

## Pixel

# PX40 – MATT CB

fusto in colore coprente con finitura satinata,  
clip e tappino in colore bianco coprente lucido  
solid colour barrel with matt finish, solid glossy  
white colour clip and push-button

61 magenta / tampografia 30 x 8 mm  
61 magenta / pad printing 30 x 8 mm

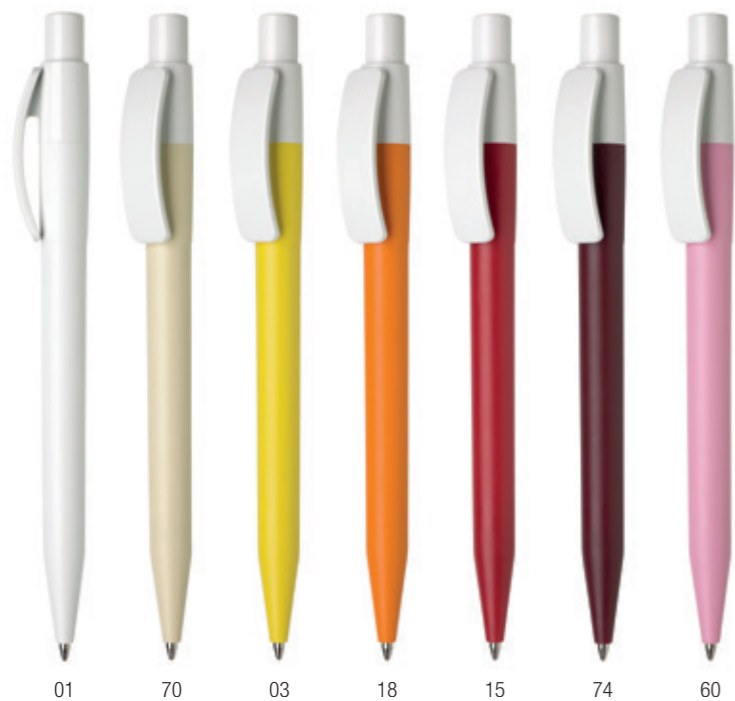

## Colori con finitura matt e clip bianca: una combinazione facile e grintosa.

*Colours with matt finish and white clip:  
an easy, gritty combination.*

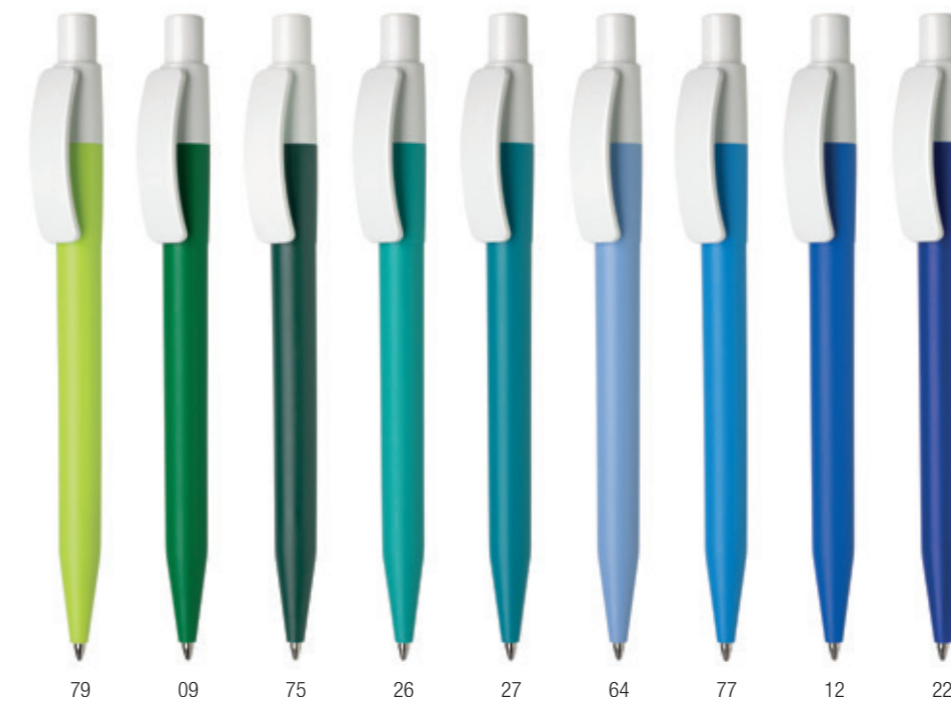

05 grigio / tampografia 30 x 8 mm  
05 grey / pad printing 30 x 8 mm





# Pixel

## PX40 – MATT CR

fusto in colore coprente con finitura satinata,  
clip in colore coprente lucido, tappino cromato  
solid colour barrel with matt finish, solid glossy  
colour clip, chromed push-button

73 marrone / tampografia 30 x 8 mm  
73 brown / pad printing 30 x 8 mm

26 acquamarina / tampografia 30 x 8 mm  
26 aquamarine / pad printing 30 x 8 mm

03 giallo / tampografia 30 x 8 mm  
03 yellow / pad printing 30 x 8 mm

64 azzurro pastello / tampografia 60 x 9 mm  
64 pastel blue / pad printing 60 x 9 mm

## Pixel

### PX40 – B

fusto e tappino in colore bianco coprente,  
clip in colori coprenti, finiture lucide  
solid white colour barrel and push-button,  
solid colours clip, glossy finishes

22 blu / tampografia 30 x 8 mm  
22 blue / pad printing 30 x 8 mm

74 bordeaux / tampografia 30 x 8 mm  
74 burgundy / pad printing 30 x 8 mm



01 03 18 15



09 12



04

## Pixel

### PX40 – C

colori coprenti con finitura lucida  
solid colours with glossy finish

09 verde / tampografia 30 x 8 mm  
09 green / pad printing 30 x 8 mm



70 03 18 15



04 nero / tampografia 30 x 8 mm  
04 black / pad printing 30 x 8 mm



12 22



# PX40 – 30

colori trasparenti con finitura lucida  
transparent colours with glossy finish

**Design dai tratti essenziali: uno strumento grintoso per brand dinamici.**

*Design with basic features:  
a feisty pen for dynamic brands.*

47 acquamarina / tampografia 30 x 8 mm  
47 aquamarine / pad printing 30 x 8 mm



# Pixel

# PX40 – FROST NEUTRAL

colori trasparenti, fusto con finitura satinata,  
clip e tappino con finitura lucida  
transparent colours, matt finish barrel,  
glossy finish clip and push-button

**Il tappino ventilato è conforme alle normative CEE sui piccoli componenti.**

*The ventilated push-button is compliant with EU laws for small components.*

55 viola scuro / tampografia 30 x 8 mm  
55 dark violet / pad printing 30 x 8 mm



53 arancio / tampografia 30 x 8 mm  
53 orange / pad printing 30 x 8 mm



**Pixel**

# PX40 – FROST

colori trasparenti, fusto con finitura satinata,  
clip e tappino con finitura lucida  
transparent colours, matt finish barrel,  
glossy finish clip and push-button

31 lilla / tampografia 30 x 8 mm  
31 lilac / pad printing 30 x 8 mm



41 magenta / tampografia 30 x 8 mm  
41 magenta / pad printing 30 x 8 mm



**new  
colors**

59 rosa / 59 pink  
41 magenta / 41 magenta  
31 lilla / 31 lilac  
37 ambra / 37 amber  
38 marrone / 38 brown  
78 lime / 78 lime  
34 azzurro / 34 light blue  
67 ciano / 67 cyan  
50 grigio scuro / 50 dark grey



78 lime / tampografia 30 x 8 mm  
78 lime / pad printing 30 x 8 mm

**9 nuovi colori  
disponibili!**

*9 new colors available!*

## Pixel

# PX40 – GOM C CR

fusto in colore coprente gommato, clip in colore  
coprente con finitura lucida, tappino cromato  
solid colour barrel with rubber finish, solid colour  
clip with glossy finish, chromed push-button

04 nero / tampografia 30 x 8 mm  
04 black / pad printing 30 x 8 mm

15 rosso / tampografia 30 x 8 mm  
15 red / pad printing 30 x 8 mm



## Pixel

# PX40 – GOM 30 CR

fusto in colore coprente gommato, clip in colore  
trasparente con finitura lucida, tappino cromato  
solid colour barrel with rubber finish, transparent  
colour clip with glossy finish, chromed push-button

47 acquamarina / tampografia 30 x 8 mm  
47 aquamarine / pad printing 30 x 8 mm



41 magenta / tampografia 30 x 8 mm  
41 magenta / pad printing 30 x 8 mm

---

# Bay

disinvolta e accattivante  
*casual and attractive*



**Attrae per  
la sua semplicità.**

*Draws attention for its simplicity.*

**Bay**  
informazioni  
tecniche  
*technical  
information*

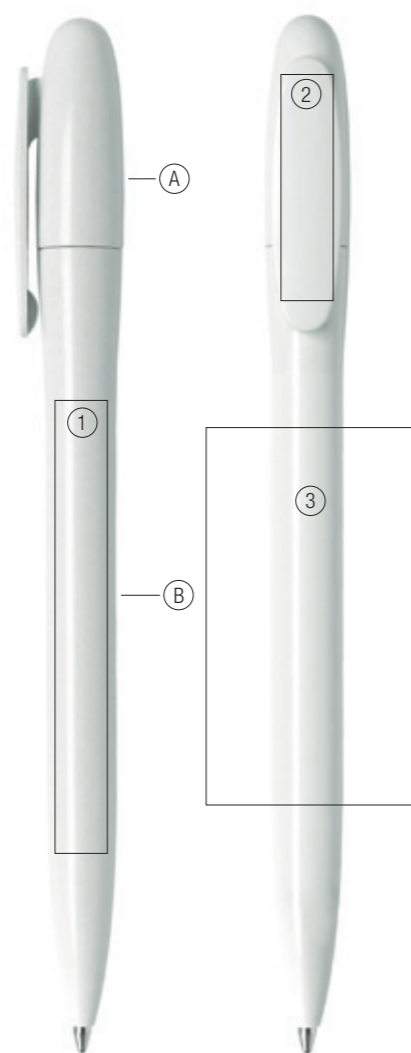

Vai su **maxema.com**  
per scegliere i tuoi  
colori preferiti.

Go to **maxema.com** to choose  
your favourite colours.

- Ⓐ cappuccio      Ⓐ cap
- Ⓑ fusto            Ⓑ barrel

1/4

**CARATTERISTICHE**

- meccanismo a rotazione
- realizzata in plastica ABS, atossica e ad alta resistenza
- refill X-20, inchiostro blu e nero
- disponibile con superfici lucide o satinare

**FEATURES**

- twist-action
- made of non-toxic, highly resistant ABS plastic
- X-20 refill, blue and black ink
- available in glossy or matt finish

2/4

**AREA STAMPABILE**

- ① tampografia 60 x 7 mm
- ② tampografia 30 x 7 mm
- ③ serigrafia 50 x 28 mm

**PRINT AREA**

- ① pad printing 60 x 7 mm
- ② pad printing 30 x 7 mm
- ③ screen printing 50 x 28 mm

3/4

**FUSTO**

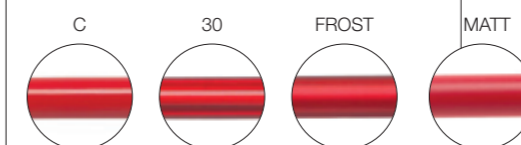

**BARREL**

**CAPPUCCIO**

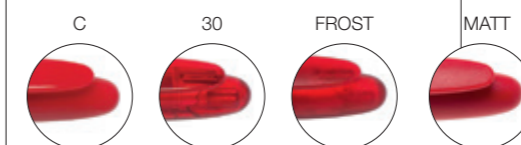

**CAP**

4/4

**COLORAZIONI**

- coprenti
- ① 01 70 03 18 15 74 60 61 71
- trasparenti
- ② 39 52 53 45 51 55 49 47 44

**COLOURS**

- solid
- ③ 25 73 79 09 75 26 27 64 77 12 22 05 04
- transparent
- ④ 40

# Bay B500 – MATT BC

fusto in colore bianco coprente, cappuccio  
in colori coprenti, finiture satinare  
solid white colour barrel, solid colours cap,  
matt finishes



70 03 18 15 74

PAIDEIA  
FONDAZIONE

60 rosa / tampografia 30 x 7 mm  
60 pink / pad printing 30 x 7 mm

61 71 25 73 79

09

Wilmington  
College

75 verde scuro / tampografia 30 x 7 mm  
75 dark green / pad printing 30 x 7 mm  
—  
tampografia 60 x 7 mm  
pad printing 60 x 7 mm

26 27 64 77 12 22 05

04 nero / tampografia 60 x 7 mm  
04 black / pad printing 60 x 7 mm

AIR NEW ZEALAND



**Bay**

# B500 – MATT

colori coprenti con finitura satinata  
solid colours with matt finish

73 marrone / tampografia 60 x 7 mm  
73 brown / pad printing 60 x 7 mm



**Effetto satinato:  
raffinata delicatezza  
declinabile in 22 colori.**

*Delicately refined matt finish in 22 colours.*



01 bianco / tampografia 30 x 7 mm  
01 white / pad printing 30 x 7 mm



27 ottanio / tampografia 30 x 7 mm  
27 octan green / pad printing 30 x 7 mm

## Bay

### B500 – BC

fusto in colore bianco coprente,  
cappuccio in colori coprenti, finiture lucide  
solid white colour barrel, solid colours cap,  
glossy finishes

22 blu / tampografia 60 x 7 mm  
22 blue / pad printing 60 x 7 mm



## Bay

### B500 – C

colori coprenti con finitura lucida  
solid colours with glossy finish

04 nero / tampografia 30 x 7 mm  
04 black / pad printing 30 x 7 mm

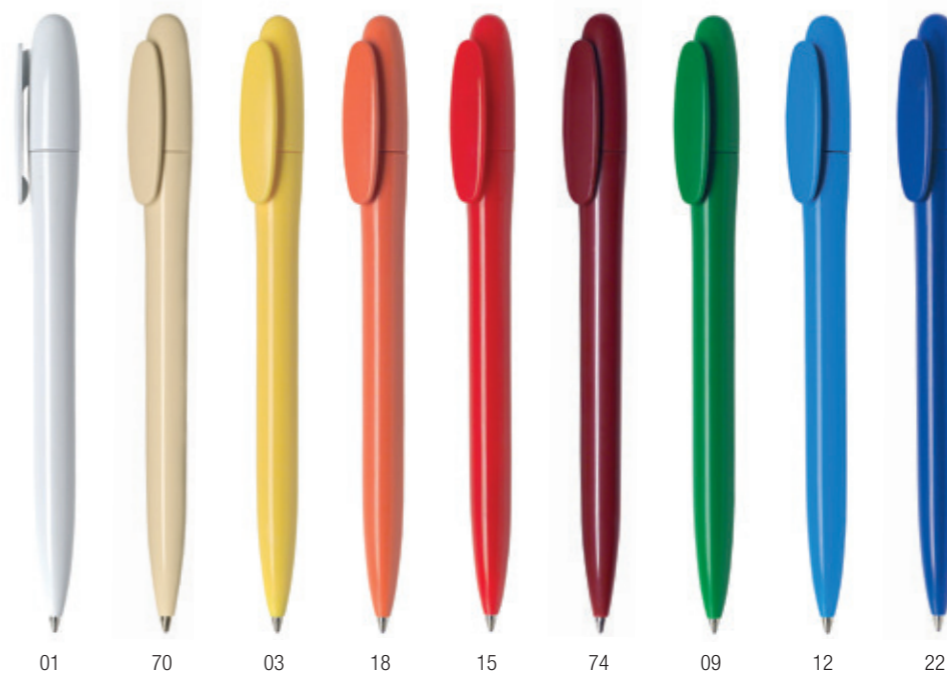

## Bay

### B500 – 30

colori trasparenti con finitura lucida  
transparent colours with glossy finish

47 acquamarina / tampografia 30 x 7 mm  
47 aquamarine / pad printing 30 x 7 mm



39 52 53



51 55 49



44 40

45 rosso / tampografia 30 x 7 mm  
45 red / pad printing 30 x 7 mm



## Bay

### B500 – FROST

colori trasparenti con finitura satinata  
transparent colours with matt finish

55 viola scuro / tampografia 30 x 7 mm  
55 dark violet / pad printing 30 x 7 mm



52 53 45 51



49 44 40

39 neutro / tampografia 60 x 7 mm  
39 neutral / pad printing 60 x 7 mm

## Packaging My Case

### TAMPOGRAFIA / PAD PRINTING

- ① 4,2 x 16,6 cm
- ② 4,3 x 14,8 cm

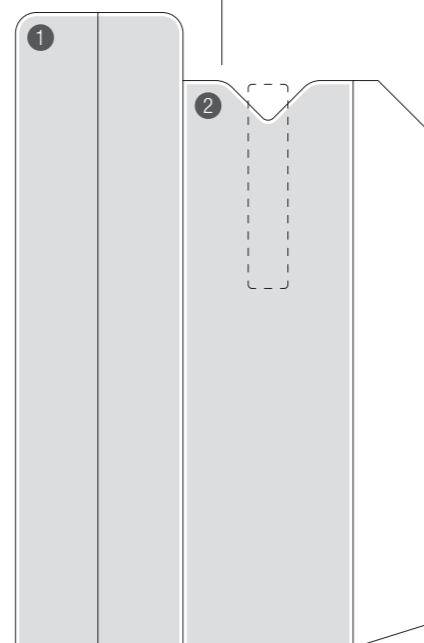

- astuccio universale per penna singola in cartoncino Fedrigoni Ultra Black 280 gr/m<sup>2</sup>, personalizzabile con stampa tampografica
- dimensioni: 4,4 x 16,8 cm

- universal single pen case in Fedrigoni Ultra Black 280 g/m<sup>2</sup> card, personalisable with pad printing
- size: 4,4 x 16,8 cm

## Packaging My Box

### TAMPOGRAFIA / PAD PRINTING

- ① 14,8 x 2 cm
- ② 14,9 x 2 cm
- ③ 14,8 x 2 cm
- ④ 14,8 x 2 cm

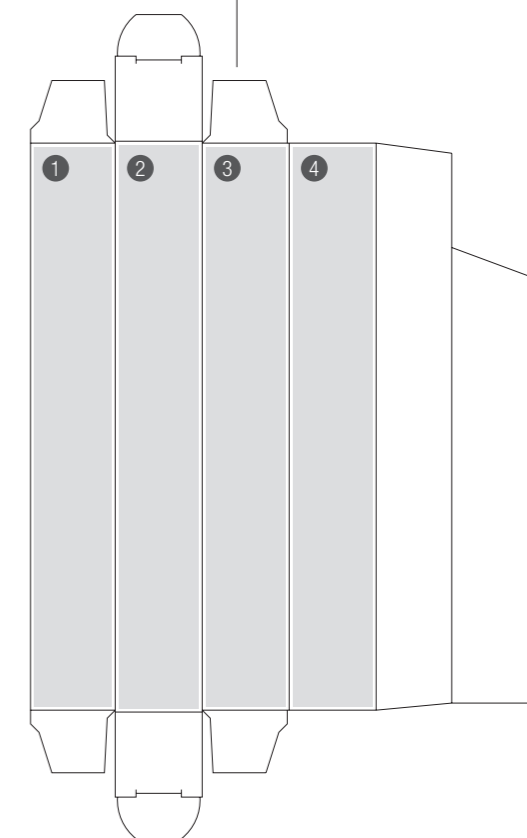

- astuccio universale richiudibile per penna singola in cartoncino Fedrigoni Ultra Black 280 gr/m<sup>2</sup>, personalizzabile con stampa tampografica
- dimensioni: 2,3 x 15,1 x 2,3 cm

- universal reclosable single pen case in Fedrigoni Ultra Black 280 g/m<sup>2</sup> card, personalisable with pad printing
- size: 2,3 x 15,1 x 2,3 cm

**Supporti di vendita**  
*sales support*

Maxema Playlist

# PLAY THE COLOR YOU WANT

Maxema presenta la sua Playlist. Partecipano tutti i colori coprenti al massimo della loro forza espressiva.

Maxema presents its Playlist. All the solid colors take part at the limit of their expressive powers.

## Supporti di vendita

sales support

Maxema Playlist

**Segui il tuo ritmo  
e scegli il tuo colore  
tra i 28 della  
nostra Playlist.**

*Follow your rhythm and choose your color  
from the 28 on our Playlist.*



Maxema Playlist è composta da 2 Box, ciascuno contenente 14 Minikit. Ogni Minikit contiene 5 penne stampate in modelli assortiti del colore indicato in copertina.

The Maxema Playlist consists of 2 Boxes, each containing 14 Minikits. Each Minikit contains 5 printed pens, in assorted models, in the color indicated on the cover.



### BOX

- Box 1: contiene 14 Minikit con i colori illustrati nell'immagine
- Box 2: contiene 14 Minikit con i colori illustrati nell'immagine
- dimensioni: 29,6 x 20 x 15,3 cm

### BOXES

- Box 1: contains 14 Minikits with the colours shown in the image
- Box 2: contains 14 Minikits with the colours shown in the image
- size: 29,6 x 20 x 15,3 cm

Supporti di vendita  
sales support

Maxema Playlist

# Per ogni colore coprente della nostra Palette Colori esiste un Minikit dedicato.

*There is a dedicated Minikit for every  
solid colour in our Colour Palette.*



**Supporti di vendita**  
sales support

Minikit

Maxema Playlist



**MINIKIT MAXEMA PLAYLIST**

- 5 penne stampate dei modelli più rappresentativi, nel colore indicato sulla copertina del Minikit
- dimensioni: 14,7 x 19 cm (formato chiuso)

**MAXEMA PLAYLIST MINIKIT**

- 5 printed pens of the most representative models in the colour suggested on the Minikit cover
- size: 14,7 x 19 cm (closed format)

**Supporti di vendita**  
sales support

Minikit



**La selezione essenziale dei nostri best seller: i Minikit sono strumenti preziosi da esporre, consultare, collezionare.**

*The essential selection of our best sellers: Minikits are valuable tools to display, consult and collect.*



**MINIKIT GENERICO**

- 5 penne stampate in colori assortiti dei modelli più rappresentativi
- dimensioni: 14,7 x 19 cm (formato chiuso)

**GENERAL MINIKIT**

- 5 printed pens in assorted colours of the most representative models
- size: 14,7 x 19 cm (closed format)



**Supporti di vendita**  
sales support

Kit e  
raccolgitori  
Kit and box sets

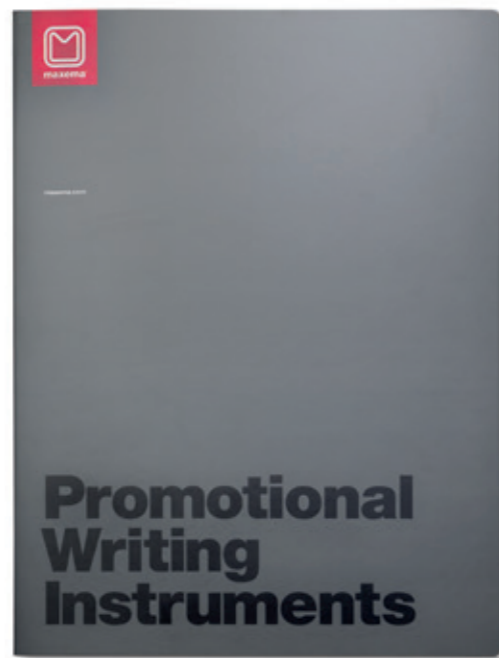

**KIT**

- 20 penne stampate in colori assortiti dei modelli più rappresentativi
- dimensioni: 25 x 34 cm (formato chiuso)

**KIT**

- 20 printed pens in assorted colours of the most representative models
- size: 25 x 34 cm (closed format)

**RACCOLGITORI**

- i Kit sono disponibili in raccoglitori da 1, 2 o 3
- ① 28 x 33 x 3 cm
- ② 28 x 33 x 5,5 cm
- ③ 28 x 33 x 8 cm

**BOX SETS**

- the Kits are available in 1, 2 or 3 unit box sets
- ① 28 x 33 x 3 cm
- ② 28 x 33 x 5,5 cm
- ③ 28 x 33 x 8 cm



**KIT MODELLO**

- 20 penne stampate in colori assortiti di un unico modello
- dimensioni: 25 x 34 cm (formato chiuso)
- il Kit Modello è disponibile per: Mood, Flow Pure, Flow, Dot, Zink, View, Tag, Icon, Icon Green, Tag Green, Ethic, Pixel, Next, Bay.

**MODEL KIT**

- 20 printed pens in assorted colours of a single model
- size: 25 x 34 cm (closed format)
- the Model Kit is available for: Mood, Flow Pure, Flow, Dot, Zink, View, Tag, Icon, Icon Green, Tag Green, Ethic, Pixel, Next, Bay.

**Su richiesta si possono realizzare campionari personalizzati con penne di specifiche versioni e colori.**

**On request we can prepare customised sets of samples containing specific versions and colours of pens.**

## Palette colori

colour palette

### coprenti / solid

01 bianco white	70 crema cream	03 giallo yellow	18 arancio orange	15 rosso red	74 bordeaux burgundy
60 rosa pink	61 magenta magenta	71 viola chiaro light violet	25 viola scuro dark violet	72 cuoio leather	73 marrone brown
79 lime lime	09 verde green	75 verde scuro dark green	26 acquamarina aquamarine	27 ottanio octan green	64 azzurro pastello pastel blue
77 ciano cyan	12 azzurro light blue	22 blu blue	05 grigio grey	04 nero black	

### trasparenti / transparent

39 neutro neutral	52 giallo yellow	53 arancio orange	45 rosso red	59 rosa pink	41 magenta magenta
31 lilla lilac	51 viola violet	55 viola scuro dark violet	37 ambra amber	38 marrone brown	78 lime lime
49 verde green	47 acquamarina aquamarine	34 azzurro light blue	67 ciano cyan	44 blu blue	30 grigio chiaro light grey
40 grigio grey	50 grigio scuro dark grey				

### Icon green e Tag green coprenti / solid Icon green and Tag green

01 bianco white	70 crema cream	42 giallo yellow	43 arancio orange	35 rosso red	13 marrone brown
29 verde green	65 verde scuro dark green	77 ciano cyan	54 blu blue	04 nero black	

### vernici metallizzate / metallic paintings

91 perla pearl	92 oro gold	83 rame copper	85 rosso red	81 viola violet	82 viola scuro dark violet
89 verde green	94 avio aviation	95 blu blue	96 antracite anthracite	alluminio aluminium	

### fluo coprenti / solid fluo

02 giallo yellow	17 arancio orange	14 rosso corallo coral red	56 fucsia fuchsia	08 verde green
------------------	-------------------	----------------------------	-------------------	----------------

### fluo trasparenti / transparent fluo

20 giallo yellow	33 arancio orange	24 rosso corallo coral red	46 fucsia fuchsia	48 verde green
------------------	-------------------	----------------------------	-------------------	----------------

### trattamento galvanico / galvanic process

cromato chrome	dorato gold	oro gold	cromato chrome	oro rosa rose gold
----------------	-------------	----------	----------------	--------------------

### finiture metallo / metal finishes

oro gold	cromato chrome	oro rosa rose gold
----------	----------------	--------------------

## Codici pantone

pantone codes

In questa tabella sono riportati i nostri colori con i codici Pantone che più si avvicinano a quelli della nostra Palette. La corrispondenza è puramente indicativa.

Our colour chart is shown below with the Pantone codes closest to those of our Palette. Matches are approximate.

### coprenti / solid

01 bianco / white	70 crema / cream	03 giallo / yellow	18 arancio / orange	15 rosso / red	74 bordeaux / burgundy
60 rosa / pink	61 magenta / magenta	71 viola chiaro / light violet	25 viola scuro / dark violet	72 cuoio / leather	73 marrone / brown
79 lime / lime	09 verde / green	75 verde scuro / dark green	26 acquamarina / aquamarine	27 ottanio / octan green	64 azzurro pastello / pastel blue
77 ciano / cyan	12 azzurro / light blue	22 blu / blue	05 grigio / grey	04 nero / black	

pant 7499
pant 120
pant 1505
pant 187
pant 195
pant 1905
pant 213
pant 270
pant violet
pant 7571
pant 7582
pant 381
pant 348
pant 3435
pant 3262
pant 321
pant 283
pant 2995
pant 285
pant 287
pant cool gray 6
pant black 6

### trasparenti / transparent

39 neutro / neutral
52 giallo / yellow
53 arancio / orange
45 rosso / red
59 rosa / pink
41 magenta
31 lilla / lilac
51 viola / violet
55 viola scuro / dark violet
37 ambra / amber
38 marrone / brown
78 lime / lime
49 verde / green
47 acquamarina / aquamarine
34 azzurro / light blue
67 ciano / cyan
44 blu / blue
30 grigio chiaro / light grey
40 grigio / grey
50 grigio scuro / dark grey

pant 116
pant 1505
pant 200
pant 1905
pant 213
pant 2705
pant 2425
pant violet
pant 7571
pant 7582
pant 381
pant 348
pant 3435
pant 3262
pant 321
pant 283
pant 2995
pant 285
pant 287
pant cool gray 6
pant 437
pant 446

### Icon green e Tag green coprenti / solid Icon green and Tag green

01 bianco / white	70 crema / cream	42 giallo / yellow	43 arancio / orange	35 rosso / red	13 marrone / brown
29 verde / green	65 verde scuro / dark green	77 ciano / cyan	54 blu / blue	04 nero / black	

pant 7499
pant 012
pant 151
pant 179
pant 7532
pant 7741
pant 343
pant 2995
pant 7685
pant black 6

I colori Pantone sono disponibili su richiesta, contattateci per conoscere i quantitativi minimi per ogni modello.

Pantone colours are available on demand. Please contact us to find out the minimum order quantity for each model.

# Inchiostri e refill

*inks and refills*

## inchiostri / inks



blu  
blue



nero  
black

### X-20



sfera in acciaio Ø 1 mm, lunghezza 107 mm, fino a 2000 metri di scrittura  
ball stainless steel Ø 1 mm, length 107 mm, for up to 2000 meters of writing

### jumbo



sfera in acciaio Ø 1 mm, lunghezza 107 mm, fino a 2500 metri di scrittura  
ball stainless steel Ø 1 mm, length 107 mm, for up to 2500 meters of writing

### RT 90 tipo Parker / Parker type



sfera in acciaio inox Ø 0,8 mm, lunghezza 98 mm, fino a 4000 metri di scrittura  
ball stainless steel Ø 0,8 mm, length 98 mm, for up to 4000 meters of writing

### RT 90 su richiesta / on demand



sfera in acciaio inox Ø 1 mm, lunghezza 98 mm, fino a 4000 metri di scrittura  
ball stainless steel Ø 1 mm, length 98 mm, for up to 4000 meters of writing

### GEL FAST DRY su richiesta / on demand



sfera in carburo di titanio (SS, TC) diametro 0,7 mm, punta in acciaio inox,  
lunghezza 98 mm, fino a 700 metri di scrittura.  
ball in titanium carbide (SS, TC), diameter 0.7 mm, tip in stainless steel,  
length 98 mm, up to 700 meters of writing

**Il tubetto del refill è in polipropilene,  
la punta è in ottone nichelato.  
L'inchiostro, atossico, è Dokumental.  
Tutti gli inchiostri Dokumental  
sono conformi alla normativa europea  
REACH e americana TSCA.**

**The refill's barrel is made of polypropilene,  
the tip is made of nickel-plated brass.  
The non-toxic ink is Dokumental.  
All Dokumental inks comply with European  
REACH and American TSCA standards.**

**Inchiostro gel a base acqua, atossico  
e prodotto in Italia, conforme  
alla normativa europea REACH  
e americana TSCA.  
Il tubetto del refill è in polipropilene.**

**Water-based, non-toxic gel ink, produced  
in Italy and compliant with European REACH  
and American TSCA standards.  
The refill's barrel is made of polypropilene.**

**tutti i diritti riservati maxema srl  
all rights reserved maxema srl**

I marchi menzionati in questo catalogo sono di proprietà esclusiva dei rispettivi proprietari. L'utilizzo dei suddetti marchi è a puro titolo esemplificativo e non potrà mai, in alcun caso, essere oggetto di trattative commerciali.

The brands mentioned in this catalogue are the exclusive property of the respective owners. They are used for purely illustrative purposes and cannot be the object of any buying and selling transactions, under any circumstances.

art direction and graphic design  
**undesign.it**

still life  
**infinitostudio.com**

editing  
**elena ambrosio  
sara zampedri**



MADE IN ITALY  
— PRODOTTO  
IN ITALIA —  
FABRIQUE EN  
ITALIE — FABRI-  
CADO EN ITALIA



